

USER AND INSTALLATION MANUAL

Ecosine Flex Passive Harmonic Filters



Revision: 03 (December 2023)

English version (original instructions)

The most current edition of this document (PDF format) can be obtained from your contact of the Schaffner organization or at [schaffner.com/downloads](https://www.schaffner.com/downloads).

Other technical documentations of our products are also available in the download area of our website [schaffner.com](https://www.schaffner.com).

Document name:

User and installation manual Ecosine Flex Passive Harmonic Filters rev03.pdf

Valid for Ecosine Flex Passive Harmonic Filters version:

FN3446 series for 380-480 VAC at 50 Hz

FN3458 series for 380-480 VAC at 60 Hz

Version history

Revision	Date	Description
01	July 2023	Initial version
02	October 2023	Section 2.2 had the tables not formatted properly and frame sizes incorrect. This is now corrected. Section 3.6 Required airflow for FN3446-110 and FN3458-125 updated.
03	December 2023	Sections 3.1 and 3.2 foot note added for exception in maximum ambient temperature on 200 kW and 300 HP versions. Section 3.6 addition of Figure 2 for air flow direction

i. Ecosine Flex Passive Harmonic Filters product highlights

Schaffner Ecosine Flex Passive Harmonic Filters are configurable products which provide an economical solution for current harmonics mitigation of 3-phase 6 pulse non-linear loads.

The two product lines, FN3446 and FN3458 are applicable for low voltage 50 Hz and 60 Hz systems respectively and they are particularly suitable for AC and DC motor drives, battery chargers and other power electronics applications with 6-pulse front-end rectifiers.

Ecosine Flex Passive Harmonic Filters are the most economical harmonic mitigation solution to reach 10% THDi and introduce the following aspects of novelty:

- **Ecosine Flex provides a ready to use solution for the most competitive projects.** Ecosine Flex Passive Harmonic Filters are designed for three-phase diode and thyristor rectifier. It allows to reach performances below 10% THDi with drives equipped with $\geq 4\%$ DC-Link choke (L_{dc}). It can also be used with drives equipped with a DC-Link choke $< 4\%$ or without DC-Link choke for a performance below 15% THDi. The new generation Ecosine Flex Passive Harmonic Filters targets the requirement of EN 61000-3-12 and IEEE-519 for $I_{sc}/I_L < 50$ and other stringent international power quality standards.
- Most compact design, robust, reliable and ready to use.
- The upgraded version of the Schaffner power quality simulator SchaffnerPQS3 (pqs.schaffner.com) provides the possibility to simulate Ecosine Flex Passive Harmonic Filters within an electrical system. It furthermore offers quick and accurate performance checks.

This user manual is intended to support designers, installers, and application engineers with filter selection, installation, application, and maintenance. It provides helpful solutions to overcome harmonics mitigation challenges and answers frequently asked questions.

If you require additional support, please feel free to contact your local Schaffner representative.

ii. Performance Guarantee

By selecting and installing the appropriate ecosine evo passive harmonic filter in a variable frequency AC drive application, variable speed drive application within our published technical specifications, we guarantee that the input current distortion will be less than or equal to 15% THDi for standard Ecosine Flex series filters at rated power when used with drive not equipped with EMI filter, and 10% THDi for drives with $\geq 4\%$ Ldc and no EMI filter. Ecosine Flex filters can also provide similar performance in other drive applications such as, drive with EMI filter, constant torque, DC drives or other phase-controlled rectifiers, e.g. SCR drives, but actual THDi levels can vary by load and/or speed and/or firing angle of thyristors and therefore cannot be guaranteed. Consult your local Schaffner representative for assistance when applying ecosine filters on these types of equipment.

iii. Minimum system requirements

The guaranteed performance levels of this filter will be achieved when the following system conditions are met:

- Type of load: Any 3-phase equipment with front-end six-pulse diode rectifier.
- Type of source: 3-phase power line without neutral
- Line impedance: $< 3\%$ (calculated for the rated filter power)
- Line frequency: 50 Hz ± 1 Hz (FN3446), 60 Hz ± 1 Hz (FN3458)
- Line voltage: Nominal line voltage $\pm 10\%$
- Line voltage unbalance: $< 1\%$
- Line voltage distortion: THDv $< 2\%$

iv. Important user notice



Schaffner Ecosine Flex Passive Harmonic Filters are designed for the operation on the input (grid) side of power electronic equipment with six-pulse rectifier front-end in balanced three-phase power systems, like typically used in AC or DC motor drives and high-power DC supplies. Filter suitability for a given application must be determined by the user on a case-by-case basis. Schaffner will not assume liability for any consequential downtimes or damages resulting from use or application of Ecosine filters outside of their specifications. Ecosine filters are not designed for single-phase or split-phase applications.

v. General Safety Notes and Installation Guidelines (Cautions and Warnings)

1. Important Information

These general safety notes refer to the group of power quality filters including active and passive harmonic filter (AHF, PHF), AC line chokes and output filters. Do not attempt to install, operate, maintain or inspect power quality filters until you have read through the safety notes and installation guidelines as well as installation manual and product specification. Do not use any Schaffner product until you have a full knowledge of the equipment, safety notes and installation guidelines. The same applies to all warnings placed on the filters. Please ensure that those are not removed and their legibility is not influenced by external factors.

The following symbols, terms and designations are used in these general safety notes and installation guidelines:

Label	Description
 CAUTION	Follow these instructions to avoid hazardous conditions which could cause minor or moderate injury or may cause damages to the unit.
 WARNING	Follow these instructions to avoid hazardous conditions which could result in death or serious injury.
NOTICE	Indicates content to be noted by the reader.

2. General Installation Notes

- ▶ Please read and follow the safety and application notes below.
- ▶ Carefully inspect the shipping container and the product prior to the installation. In case of visual damage, don't install the filter and file a claim with the freight carrier involved.
- ▶ Filters may be heavy. Follow the instructions for lifting heavy equipment defined by your company.
- ▶ Use an appropriately sized threaded bolt for every mounting hole/slot provided by the filter flange. The strength class of the bolt must be determined by the installer, depending upon filter weight and the material of the mounting surface.
- ▶ Connect the filter to the protective earth (PE) terminal(s).
- ▶ Remove all line side power, then connect the phase terminal(s) and neutral terminal (if any) of the filter. The filter label may also indicate LINE (grid side terminals) and LOAD (power electronics terminals).
- ▶ For the electrical connection of the filter terminals, apply the torques recommended on the filter label and/or in the published filter datasheets.
- ▶ Cable or busbar cross sections have to be chosen in accordance with national and international electric codes and applicable product standards governing the equipment that will incorporate the power quality filters and the equipment in use.
- ▶ Some filters provide additional terminals, e.g. for over-temperature monitoring. These features have to be properly used before energizing the filter. If uncertain, please consult your local Schaffner representative.
- ▶ Active Harmonic Filters (AHF) are working with current transformers (CTs) which are a 3rd party product and which are typically installed in electrical equipment with lethal high voltage levels. Before attempting to install CTs read the CT installation safety page provided by the CT manufacturer. Always consider transformer as a part of the circuit to which it is connected, and do not touch the leads and terminals or other parts of the transformer unless they are known to be grounded.
- ▶ In order to get the maximum benefit out of your power quality filter, please also consult additional user manuals, installation manuals, whitepaper and other material, published in the download section of www.schaffner.com. These additional guidelines provide helpful hints for equipment related topics as well as technical knowledge.

3. Safety Notes and Regulations



















1. Label on equipment 2. Safety note category	Safety note regulations
 	Equipment installation, start-up, operation and maintenance (if any) have to be carried out by a trained and certified electrician or technician, who is familiar with safety procedures in electrical systems. Non-qualified persons are not allowed to use, install, operate or maintain PQ filters!
 	High voltage potentials are involved in the operation of power quality equipment. Always remove power before handling energized parts of the filter, and let ample time elapse for the capacitors to discharge to safe levels (<42V). Residual voltages are to be measured both line to line and line to earth.
 	Correct protective earthing of the equipment must be established and the user must be protected against supply voltage in accordance with applicable national and local regulations. Always practice the safety procedures defined by your company and by applicable national electric codes when handling, installing, operating or maintaining electrical equipment.
 	Some product may include EMC filters which may cause leakage currents to ground. Always connect the filter to protective earth (PE) first, then continue with the wiring of phase/neutral terminals. When decommissioning the filter, remove the PE connection at the end.
 	Using the direct OFF setting in AHF does not disconnect the equipment from mains and is thus not to be used as a safety switch.
 	Follow the general installation and environmental condition notes closely. Ensure that cooling slots (if any) are free from obstructions that could inhibit efficient air circulation. Operate the filter within its electrical, mechanical, thermal and ambient specifications at all times.
 	Power quality filters are lossy electrical components. Parts/surfaces of the equipment may get hot under load operating conditions.
	At altitudes above 2000m, please contact Schaffner prior to installation.
	Filter suitability for a given application must ultimately be determined by the user (the party that is putting the filter into operation) on a case by case basis. Schaffner will not assume liability for any consequential downtimes or damages resulting from use of filters outside their specifications.
 	In case of uncertainty and questions please contact your local Schaffner partner for assistance (details per region available at www.schaffner.com).

Table of Contents

1	Ecosine Flex Passive Harmonic Filters designation	7
1.1	Explanation of Ecosine Flex designation	7
1.2	Selection of Ecosine Flex filter	7
2	Filter selection.....	8
2.1	Filter selection table FN3446 (50 Hz, 3×380 ... 480 VAC)	10
2.2	Filter selection table FN3458 (60 Hz, 3×380 ... 480 VAC)	12
2.3	Filter configurations	14
3	Filter description	15
3.1	General electrical specifications FN3446 (50 Hz filters).....	15
3.2	General electrical specifications FN3458 (60 Hz filters).....	16
3.3	Additional electrical specifications.....	17
3.3.1	Clearance derating by altitude.....	17
3.3.2	Current derating by altitude	17
3.4	Screw size, torque and cable cross-section requirement.....	17
3.4.1	Filter terminals	17
3.4.2	Earth terminals	18
3.5	Thermal protection switch specifications	18
3.6	Cooling requirement.....	19
3.7	Mechanical frame sizes	20
3.8	Ecosine Flex filter footprint and dimensions	22
3.9	Filter performance	28
3.9.1	Additional considerations regarding the performances	29
3.10	Functional diagram.....	30
4	Filter appearance and elements.....	31
5	Performance estimation using SchaffnerPQS	32
6	Filter application	33

7	Filter installation	34
7.1	Step 1: Visual inspection	34
7.2	Step 2: Mounting.....	34
7.2.1	Fixation	35
7.2.2	Screws and bolts selection	35
7.2.3	Filter placement	35
7.3	Step 3: Wiring.....	36
7.3.1	Verify safe disconnection of all line side power.....	36
7.3.2	Carefully connect protective earth (PE) wire to adequate earth potential close to Ecosine filter. 36	36
7.3.3	Connect PE cable of Ecosine filter	36
7.3.4	Connect Ecosine load side terminals L1', L2', L3' to respective motor drive or rectifier inputs. 37	37
7.3.5	Use wired trap circuit or install external capacitive current control.	37
7.3.6	Connect monitor switch TS- TS'	37
7.3.7	Connect Ecosine line side terminals L1, L2, L3 to power input protection (current limiting fuses – see below).	38
7.3.8	Fuses	39
8	Filter maintenance	41
8.1	Maintenance schedule	41
8.2	Fan	41
8.3	Power capacitors	42
8.3.1	Note regarding the storage of capacitors	42
8.4	Electrical connections.....	42
9	Trap circuit disconnect.....	43
10	Troubleshooting	44
11	Abbreviation	44

1 Ecosine Flex Passive Harmonic Filters designation

1.1 Explanation of Ecosine Flex designation

Ecosine Flex is the new generation of Schaffner 10% THDi passive harmonic filter. They are introduced with a new designation system, which contains of 4 sections connected with '-' as shown in

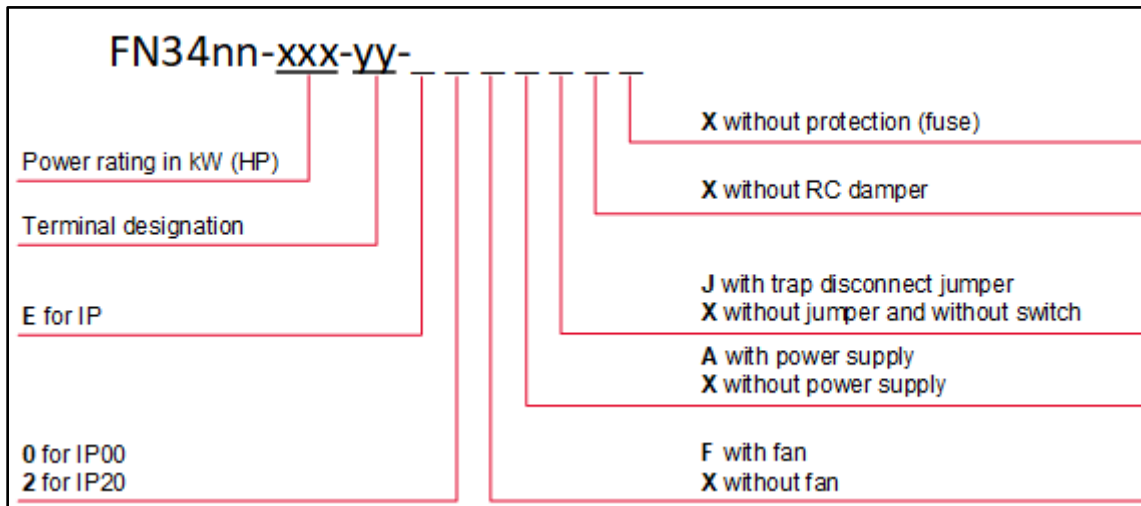

Figure 1 Ecosine Flex designation

- The first part of the designation 'FN34nn-xxx-yy-_____' distinguishes between the two series, FN3446 for network at 50Hz and FN3458 for network at 60Hz.
- The second part of the designation 'FN34nn-xxx-yy-_____' indicates the **motor drive power rating**, in kW for 50 Hz filters and in HP for 60 Hz filters. Please note that Ecosine Flex filters are not using current rating in the designation anymore.
- The third part of the designation 'FN34nn-xxx-yy-_____' indicates the power terminal type. For more information please see section 3.4.1.
- The fourth part of the designation 'FN34nn-xxx-yy-_____' contains seven slots, the first two slots reveal the protection category of the filter, e.g. E0 and E2 represent IP 00 and IP 20 enclosure. The following five slots represent the presence (F,A,R,J,P) or absence (X) of modules in the filter.

1.2 Selection of Ecosine Flex filter

Ecosine Flex filters are simple to select.

First, define the series according to the network frequency, FN3446 for 50Hz or FN3458 for 60Hz.

Secondly, choose between the IP00 (-E0_ _ _ _) or IP20 (-E2_ _ _ _) depending on your need.

Note that IP00 versions are not equipped with active cooling and it's the responsibility of the customer to ensure the appropriate cooling in the cabinet, see section 3.6 for more details. IP20 version filters are equipped with fan and the power supply for the fan when a cooling is necessary, no further requirement regarding cooling and powering of the fan is needed.

2 Filter selection

Ecosine Flex filters are simple to select according to the network frequency and the IP protection degree needed.

As an additional support from the step below, Schaffner offers the Schaffner Power Quality Simulator **SchaffnerPQS3** (pqs.schaffner.com) to select and verify the most suitable Ecosine filter for your application.

Step 1: Grid frequency

Determine, whether the system in consideration will be operated in a 50 Hz or 60 Hz electricity grid, and select the corresponding filter series according to the following table:

50 Hz grid	Europe, Middle East, parts of Asia, parts of South America	FN3446
60 Hz grid	North and Central America, parts of Asia, parts of South America	FN3458

Note: a 50 Hz filter will not provide satisfying harmonics mitigation in a 60 Hz grid, and vice versa.

Step 2: Grid voltage

Verify that the grid configuration is suitable for standard Ecosine Flex Passive Harmonic Filters according to the following table:

50 Hz grid	Nominal voltage 380–480 V AC	TN, TT, IT configuration
60 Hz grid	Nominal voltage 380–480 V AC	TN, TT, IT configuration

Step 4: Rectifier/Drive input power

The individual filter must be selected with respect to the rectifier/motor drive input power in kW respectively in HP. It is important to match rated filter power as close as possible with the effective input power of the rectifier/drive.

Note that if the rectifier/drive is being operated very close to its rated power, then the filter can be selected by the motor drive's nominal power rating. However, if the drive will be operated e.g. at only 66% of its rated power, then a smaller filter should be selected in order to get maximum harmonics mitigation performance and the optimum in terms of cost, size, and weight. In that case the customer is responsible to ensure that Ecosine Flex Passive Harmonic Filters will be operated within specification. This is particularly important in terms of overload.

Please refer to the following examples:

Example 1:

Power line rating: 400 V, 50 Hz

Drive rating: 380–500 V, 50–60 Hz, 15 kW, 22.5 A, B6-diode rectifier without DC-link choke

Planned rectifier/drive input real power: 15 kW (100% of drive rating)

➔ **Recommended filter according to the filter selection table FN3446: Type FN3446-15-33**

Example 2:

Power line rating: 480 V, 60 Hz

Drive rating: 380–500 V, 50–60 Hz, 30 HP, 41 A, diode rectifier

Planned rectifier/drive input real power: 30 HP (100% of drive rating)

➔ **Recommended filter according to the filter selection table FN3458: Type FN3458-30-33**

Oversizing of passive harmonic filters is not recommended because of the inherent lower harmonic mitigation performance at partial load as well as higher cost, size, and weight.

Please refer to Table 1 to Table 4 to select suitable filters.

2.1 Filter selection table FN3446 (50 Hz, 3×380 ... 480 VAC)

Table 1 FN3446 IP00 filter selection table

Filter	Rated load power @400 V/50 Hz	Motor drive input current	Rated filter input current	Weight	Typical losses	Input /output terminals	TDJ terminals	Frame size
	[kW]	[Arms]***	[Arms]	[kg]	[W]****	Type	Type	
FN3446-4-44-E0XXJXX	4	10	5.9	9	75	-44	-44	A
FN3446-6-44-E0XXJXX	5.5	12.5	8.1	9	129	-44	-44	A
FN3446-8-44-E0XXJXX	7.5	17.5	11.1	13	129	-44	-44	A
FN3446-11-33-E0XXJXX	11	25.1	16.2	16	203	-33	-44	B
FN3446-15-33-E0XXJXX	15	33	22.2	18	327	-33	-44	B
FN3446-19-33-E0XXJXX	19	42	27.3	21	244	-33	-44	B
FN3446-22-33-E0XXJXX	22	50	32.5	26	327	-33	-44	B
FN3446-30-34-E0XXJXX	30	67	44.5	34	370	-34	-33	C
FN3446-37-34-E0XXJXX	37	81	54.7	40	414	-34	-33	C
FN3446-45-35-E0XXJXX	45	99	66.6	43	448	-35	-33	D
FN3446-55-35-E0XXJXX	55	120	81.5	52	583	-35	-33	D
FN3446-75-40-E0XXJXX	75	160	111	80	618	-40	-34	E
FN3446-90-40-E0XXJXX	90	190	132	85	632	-40	-34	E
FN3446-110-40-E0XXJXX	110	232	164	92	790	-40	-34	E
FN3446-132-99-E0XXJXX	132	271	197	103	711	-99	-35	F
FN3446-160-99-E0XXJXX	160	328	236	114	888	-99	-35	F
FN3446-200-99-E0XXJXX	200	403	301	124	1105	-99	-40	G

* Filter rating which does not require forced cooling

** Motor drive input current without harmonic filter

*** Typical losses @ 45°C, 400 V, 50 Hz and rated load power

Table 2 FN3446 IP20 filter selection table

Filter	Rated load power @400 V/50 Hz	Motor drive input current	Rated filter input current	Weight	Typical losses	Input /output terminals	TDJ terminals	Frame size
	[kW]	[Arms]***	[Arms]	[kg]	[W]****	Type	Type	
FN3446-4-44-E2XXJXX**	4	10	5.9	10	75	-44	-44	A
FN3446-6-44-E2XXJXX**	5.5	12.5	8.1	10	129	-44	-44	A
FN3446-8-44-E2XXJXX**	7.5	17.5	11.1	15	129	-44	-44	A
FN3446-11-33-E2FAJXX	11	25.1	16.2	18	203	-33	-44	B
FN3446-15-33-E2FAJXX	15	33	22.2	20	327	-33	-44	B
FN3446-19-33-E2FAJXX	19	42	27.3	23	244	-33	-44	B
FN3446-22-33-E2FAJXX	22	50	32.5	28	327	-33	-44	B
FN3446-30-34-E2FAJXX	30	67	44.5	37	370	-34	-33	C
FN3446-37-34-E2FAJXX	37	81	54.7	43	414	-34	-33	C
FN3446-45-35-E2FAJXX	45	99	66.6	46	448	-35	-33	D
FN3446-55-35-E2FAJXX	55	120	81.5	55	583	-35	-33	D
FN3446-75-40-E2FAJXX	75	160	111	85	618	-40	-34	E
FN3446-90-40-E2FAJXX	90	190	132	91	632	-40	-34	E
FN3446-110-40-E2FAJXX	110	232	164	99	790	-40	-34	E
FN3446-132-99-E2FAJXX	132	271	197	111	711	-99	-35	F
FN3446-160-99-E2FAJXX	160	328	236	122	888	-99	-35	F
FN3446-200-99-E2FAJXX	200	403	301	132	1105	-99	-40	G

* Filter rating which does not require forced cooling

** Motor drive input current without harmonic filter

*** Typical losses @ 45°C, 400 V, 50 Hz and rated load power

2.2 Filter selection table FN3458 (60 Hz, 3×380 ... 480 VAC)

Table 3 FN3458 IP00 filter selection table

Filter	Rated load power @480 V/60 Hz		Rated load power @380 V/60 Hz		Motor drive input current [Arms]***	Rated filter input current [Arms]	Weight		Typical losses [W]****	Input /output terminals Type	TDJ terminals Type	Frame size
	[kW]	[HP]	[kW]	[HP]			[kg]	[lbs]				
FN3458-5-44-E0XXJXX	3.7	5	3	4	6.7	4.6	9	20	60	-44	-44	A
FN3458-8-44-E0XXJXX	5.6	7.5	4.5	6	10	6.9	9	20	117	-44	-44	A
FN3458-10-44-E0XXJXX	7.5	10	6	8	13.4	9.2	13.3	29	99	-44	-44	A
FN3458-15-33-E0XXJXX	11.2	15	8.9	12	20	13.8	16.2	36	174	-33	-44	B
FN3458-20-33-E0XXJXX	14.9	20	12	16	27	18.5	18.3	40	253	-33	-44	B
FN3458-25-33-E0XXJXX	19	25	15	20	34	23.0	20.9	46	307	-33	-44	B
FN3458-30-33-E0XXJXX	22	30	18	24	41	27.7	25.6	56	380	-33	-44	B
FN3458-40-34-E0XXJXX	30	40	24	32	54	36.9	33.5	74	336	-34	-33	C
FN3458-50-34-E0XXJXX	37	50	30	40	67	46.2	40	88	412	-34	-33	C
FN3458-60-35-E0XXJXX	45	60	36	48	81	55.9	42.5	94	466	-35	-33	D
FN3458-75-35-E0XXJXX	56	75	45	60	99	69.0	45.2	99	490	-35	-33	D
FN3458-100-40-E0XXJXX	75	100	60	80	131	92.2	78	172	634	-40	-34	E
FN3458-125-40-E0XXJXX	93	125	75	100	162	115	83.5	184	805	-40	-34	E
FN3458-150-40-E0XXJXX	112	150	89	120	191	139	91.5	201	615	-40	-34	E
FN3458-200-99-E0XXJXX	149	200	119	160	253	185	101	222	843	-99	-35	F
FN3458-250-99-E0XXJXX	186	250	149	200	311	231	112	246	910	-99	-35	F
FN3458-300-99-E0XXJXX	224	300	179	240	368	280	122	268	1026	-99	-40	G

* Filter rating which does not require forced cooling

** Motor drive input current without harmonic filter

*** Typical losses @ 45°C, 400V, 50Hz and rated load power

Table 4 FN3458 IP20 filter selection table

Filter	Rated load power @480 V/60 Hz		Rated load power @380 V/60 Hz		Motor drive input current [Arms]***	Rated filter input current [Arms]	Weight		Typical losses [W]****	Input/output terminals Type	TDJ terminals Type	Frame size
	[kW]	[HP]	[kW]	[HP]			[kg]	[lbs]				
FN3458-5-44-E2XXJXX**	3.7	5	3	4	6.7	4.6	10	22	60	-44	-44	A
FN3458-8-44-E2XXJXX**	5.6	7.5	4.5	6	10	6.9	10	22	117	-44	-44	A
FN3458-10-44-E2XXJXX**	7.5	10	6	8	13.4	9.2	14.7	32	99	-44	-44	A
FN3458-15-33-E2FAJXX	11.2	15	8.9	12	20	13.8	18	40	174	-33	-44	B
FN3458-20-33-E2FAJXX	14.9	20	12	16	27	18.5	19.8	44	253	-33	-44	B
FN3458-25-33-E2FAJXX	19	25	15	20	34	23.0	23.4	51	307	-33	-44	B
FN3458-30-33-E2FAJXX	22	30	18	24	41	27.7	28.2	62	380	-33	-44	B
FN3458-40-34-E2FAJXX	30	40	24	32	54	36.9	37	81	336	-34	-33	C
FN3458-50-34-E2FAJXX	37	50	30	40	67	46.2	43	95	412	-34	-33	C
FN3458-60-35-E2FAJXX	45	60	36	48	81	55.9	46	101	466	-35	-33	D
FN3458-75-35-E2FAJXX	56	75	45	60	99	69.0	48.5	107	490	-35	-33	D
FN3458-100-40-E2FAJXX	75	100	60	80	131	92.2	83	183	634	-40	-34	E
FN3458-125-40-E2FAJXX	93	125	75	100	162	115	88.5	195	805	-40	-34	E
FN3458-150-40-E2FAJXX	112	150	89	120	191	139	97.5	215	615	-40	-34	E
FN3458-200-99-E2FAJXX	149	200	119	160	253	185	109	240	843	-99	-35	F
FN3458-250-99-E2FAJXX	186	250	149	200	311	231	120	264	910	-99	-35	F
FN3458-300-99-E2FAJXX	224	300	179	240	368	280	130	286	1026	-99	-40	G

* Filter rating which does not require forced cooling

** Motor drive input current without harmonic filter

*** Typical losses @ 45°C, 400V, 50Hz and rated load power

2.3 Filter configurations

The following block diagrams represent the filter configurations.

FN34nn-xxx-yy-E2FAJXX

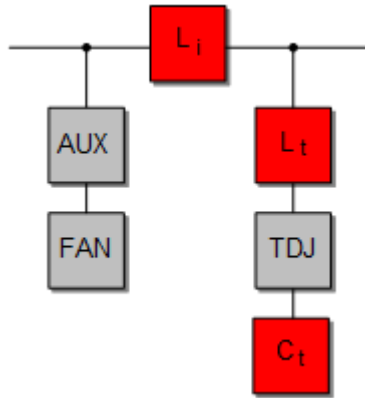

FN34nn-xxx-yy-E0XXJXX and
FN34nn-xxx-yy-E2XXJXX

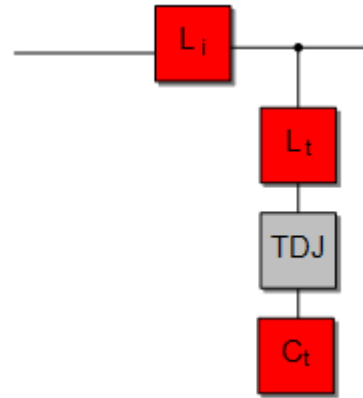

3 Filter description

3.1 General electrical specifications FN3446 (50 Hz filters)

Nominal operating voltage:	3x 380 to 480 V AC
Voltage tolerance range:	3x 342 to 528 V AC
Operating frequency:	50 Hz ±1 Hz
Network:	TN, TT, IT
Nominal motor drive input power rating:	4 to 200 kW
Total harmonic current distortion THDi: ¹⁾	< 10% @ rated power with DC-Link choke ≥ 4% < 15% @ rated power with DC-Link choke < 4%
Total demand distortion TDD: ¹⁾	According to IEEE 519
Efficiency:	≥ 98% @ nominal line voltage and power
Drive dc-link voltage:	-5% ~ +10% nominal V _{DC}
High potential test voltage: ²⁾	P → E 2480 VAC (1s)
SCCR: ³⁾	100kA, fuses according UL class J or IEC class gG
Protection category:	IP 00, IP 20
Pollution degree:	PD2 (according to standard IEC 60664-1)
Cooling:	Internal fan cooling or external cooling ⁴⁾
Overload capability:	1.6x rated current for 1 minute, once per hour
Capacitive current @ no load:	<30% of rated input current, at 400 V AC
Ambient temperature range:	-25°C to +45°C fully operational ⁵⁾ +45°C to +70°C derated operation ^{5) 6)} -25°C to +85°C transportation and storage
Flammability class:	UL 94V-2
Insulation class of magnetic components:	200(N) acc. UL 1446
Design corresponding to:	Filter: UL/IEC 61800-5-1, EN 61800-5-1 Chokes: EN 61558-2-20
MTBF @ 45°C/400 V (Mil-HB-217F):	>300,000 hours
MTTR:	<15 minutes (capacitor modules and fan modules)
Lifetime (calculated):	≥10 years with maintenance
Safety monitor output signal:	Thermal switch NC 180° C (UL-approved) to detect overload of chokes

¹⁾ System requirements: THVD <2%, line voltage unbalance <1%, line impedance <3%
Performance specification for six-pulse diode rectifiers. SCR rectifier front-end produce different results, depending upon the firing angle of the thyristors.

²⁾ Repetitive tests to be performed at max. 80% of above levels, for 2 seconds.

³⁾ External UL-rated fuses required.

⁴⁾ Please check the inlet air flow required for cooling in section 3.6.

⁵⁾ For 200 kW versions fully operational temperature up to 40°C and derated operation from 40°C.

⁶⁾ $I_{derated} = I_{nominal} \times \sqrt{\frac{(T_{max} - T_{amb})}{(T_{max} - T_{nom})}}$ with $T_{max} = 70^{\circ}\text{C}$, $T_{nom} = 45^{\circ}\text{C}$ (or 40°C for 200 kW versions)

3.2 General electrical specifications FN3458 (60 Hz filters)

Nominal operating voltage:	3x 380 to 480 V AC
Voltage tolerance range:	3x 342 to 528 V AC
Operating frequency:	60 Hz ±1 Hz
Network:	TN, TT, IT
Nominal motor drive input power rating:	5 to 300 HP (4 to 224 kW)
Total harmonic current distortion THDi: ¹⁾	< 10% @ rated power with DC-Link choke ≥ 4% < 15% @ rated power with DC-Link choke < 4%
Total demand distortion TDD: ¹⁾	According to IEEE 519
Efficiency:	≥ 98% @ nominal line voltage and power
Drive dc-link voltage:	-5% ~ +10% nominal V _{DC}
High potential test voltage: ²⁾	P → E 2480 VAC (1s)
SCCR: ³⁾	100kA, fuses according UL class J
Protection category:	IP 00, IP 20
Pollution degree:	PD2 (according to standard IEC 60664-1)
Cooling:	Internal fan cooling or external cooling ⁴⁾
Overload capability:	1.6x rated current for 1 minute, once per hour
Capacitive current @ no load:	<30% of rated input current, at 480 V AC
Ambient temperature range:	-25°C to +45°C fully operational ⁵⁾ +45°C to +70°C derated operation ^{5) 6)} -25°C to +85°C transportation and storage
Flammability class:	UL 94V-2
Insulation class of magnetic components:	200(N) acc. UL 1446
Design corresponding to:	Filter: UL/IEC 61800-5-1, EN 61800-5-1 Chokes: EN 61558-2-20
MTBF @ 45°C/400 V (Mil-HB-217F):	>300,000 hours
MTTR:	<15 minutes (capacitor modules and fan modules)
Lifetime (calculated):	≥10 years with maintenance
Safety monitor output signal:	Thermal switch NC 180° C (UL-approved) to detect overload of chokes

¹⁾ System requirements: THVD <2%, line voltage unbalance <1%, line impedance <3%
Performance specification for six-pulse diode rectifiers. SCR rectifier front-end produce different results, depending upon the firing angle of the thyristors.

²⁾ Repetitive tests to be performed at max. 80% of above levels, for 2 seconds.

³⁾ External UL-rated fuses required.

⁴⁾ Please check the inlet air flow required for cooling in section 3.6.

⁵⁾ For 300 HP versions fully operational temperature up to 40°C and derated operation from 40°C.

⁶⁾ $I_{derated} = I_{nominal} \times \sqrt{\frac{(T_{max} - T_{amb})}{(T_{max} - T_{nom})}}$ with $T_{max} = 70^{\circ}\text{C}$, $T_{nom} = 45^{\circ}\text{C}$ (or 40°C for 300 HP versions)

3.3 Additional electrical specifications

Ecosine Flex Passive Harmonic Filters general electrical specifications refer to operating altitudes up to 2000 m (6600 ft) above sea level.

Operation between 2000 m and 4000 m (6600 ft and 13'123 ft) requires a derating for clearance and current.

3.3.1 Clearance derating by altitude

Table 5 Altitude correction factors for clearances (extract from table A.2 in IEC 60664-1)

Altitude [m]	Normal barometric pressure	Multiplication factor for clearances
[m]	[kPa]	
2'000	80.0	1.00
3'000	70.0	1.14
4'000	62.0	1.29

3.3.2 Current derating by altitude

The current derating is the factor to which the nominal current needs to be multiplied. A simplified equation can be defined as function of ΔH ($H - 2000$). This equation is valid for H up to 4000 meters ($\Delta H = 2000$ m).

$$\text{Current derating } [I_n^{-1}] = -5 * 10^{-5} * \Delta H + 0.9937$$

Example: at an altitude of 3'500 m, we get $\Delta H = 1'500$ m and the current derating = 0.9187. A filter with a rated current of 100 A can only be used up to 91.87 A.

Remark: Do not use Ecosine Flex Passive Harmonic Filters in altitudes above 4000m.

3.4 Screw size, torque and cable cross-section requirement

3.4.1 Filter terminals

Several types of terminals are used in Ecosine Flex filters for both the power (input/output) terminals and the TDJ terminals but their types are not necessary the same for each filter size (e.g. FN3446-11-33 has power terminals type -33 and TDJ terminals type -44).

The terminals connecting the temperature switch (see section 3.5) is the same for all filters, type TS.

The cable cross-section must be selected according to the rated filter input current or trap current for TDJ, the maximum current, the environment and other special requirements of the application. It should be stranded copper wire cable with a temperature rating of $\geq 75^\circ\text{C}$.

The power terminals type is given by the filter designation, in the third section, see section 1.1 and in the filter selection table, see section 2.1 and 2.2 or the datasheet.

The TDJ terminals type is given in the filter selection table, see section 2.1 and 2.2 or the datasheet.

Recommended cable cross-section for each terminal type is given in Table 6. The customer is fully responsible to define the most appropriate conductor type according to the application and ensure a proper connection of the filter.

Table 6 Ecosine Flex filter terminals designation

Terminal designation	LxWxH [mm]	Stranded wire AWG	Stranded wire [mm ²]	Solid wire [mm ²]	Rec. Torque [Nm]	Ring cable shoe
-44	21.9x10x28	20 - 8	0.5 - 6	0.5 - 10	1.0 - 1.2	-
-33	25x11x32	20 - 6	0.5 - 10	0.5 - 16	1.5 - 1.8	-
-34	39x18.5x50.5	10 - 2	6 - 25	6 - 35	4.0 - 4.5	-
-35	45x20x55.5	6 - 1/0	16 - 50	10 - 50	7.0 - 8.0	-
-40	51x25x72.5	1/0 - 4/0	50 - 95	50 - 95	17 - 20	-
-99	79x6x25	-	-	-	-	M10
TS	20.5x10x10.9	24 - 10	0.5 - 4	0.5 - 6	0.7 - 0.8	-

3.4.2 Earth terminals

The earth terminals screw size and torque are given in Table 7.

Table 7 Ecosine Flex filter signal and earth terminals

Frame size	Bolt size	Torque [Nm]
A	M6	4.0
B, C	M8	9.0
D, E, F, G	M10	17

3.5 Thermal protection switch specifications

One choke of each type is equipped with a thermal protection switch (temperature switch). The 2 switches are connected in series to the auxiliary terminal TS-TS'. If the temperature switch reaches the nominal switching temperature (NST), the switch will open.

Table 8 thermal protection switch specifications

Contact type	Normally closed (NC)
Nominal switching temperature (NST)	180°C
Resetting temperature (RST)	145°C (indication only)
Operating voltage	Up to 250 V AC
Rated current AC I_{nom}	2.5A $\cos\phi = 1.0$ 1.6A $\cos\phi = 0.6$ 1.8A $\cos\phi = 0.4-0.5$

3.6 Cooling requirement

Inlet air flow requirements for each frame size are listed in Table 9. Please note that the filters with frame size A do not require air cooling. For frame sizes B to G, the required inlet air flow must be fulfilled, either by including the fan module in IP20 versions or by providing sufficient external air flow from the bottom of the filter as show on the Figure 2

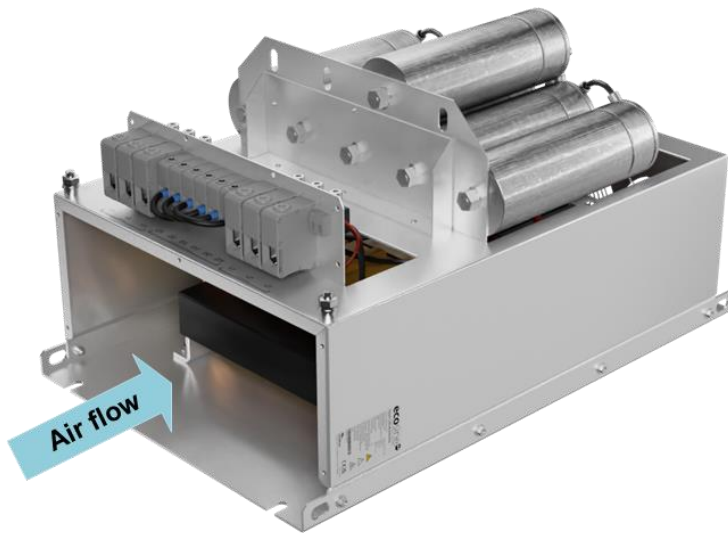

Figure 2 Mandatory air flow direction for cooling

Table 9 Air flow requirement for cooling

Frame size	Min air volume*	
	[m3/h]	CFM [ft3/min]
A	0	0
B, C, D	204	120
E - except FN3446-110-40-E0XXJXX and FN3458-150-40-E0XXJXX	408	240
E - FN3446-110-40-E0XXJXX and FN3458-150-40-E0XXJXX only	612	360
F, G	612	360

Remark: External air flow required for filter configurations without embedded Ventilation.



Important: The required inlet air flow must be provided to guarantee normal operation of the filter. Insufficient inlet air flow or blocking of air channel might cause overheating of filter components.

3.7 Mechanical frame sizes

Ecosine Flex Passive Harmonic Filters are implemented on a base plate or base frame featuring 7 different frame sizes, Frame A to Frame G, from the lowest to the highest rating. Dimensions and footprint are provided in section 3.8.

Frame sizes A do not require air flow, but frame sizes B to G in IP00 versions need external ventilation, while IP20 versions are equipped with fans and power supply for embedded active cooling. The overview of all frame sizes in IP 00 and IP 20 are shown in Figure 3 and Figure 4.

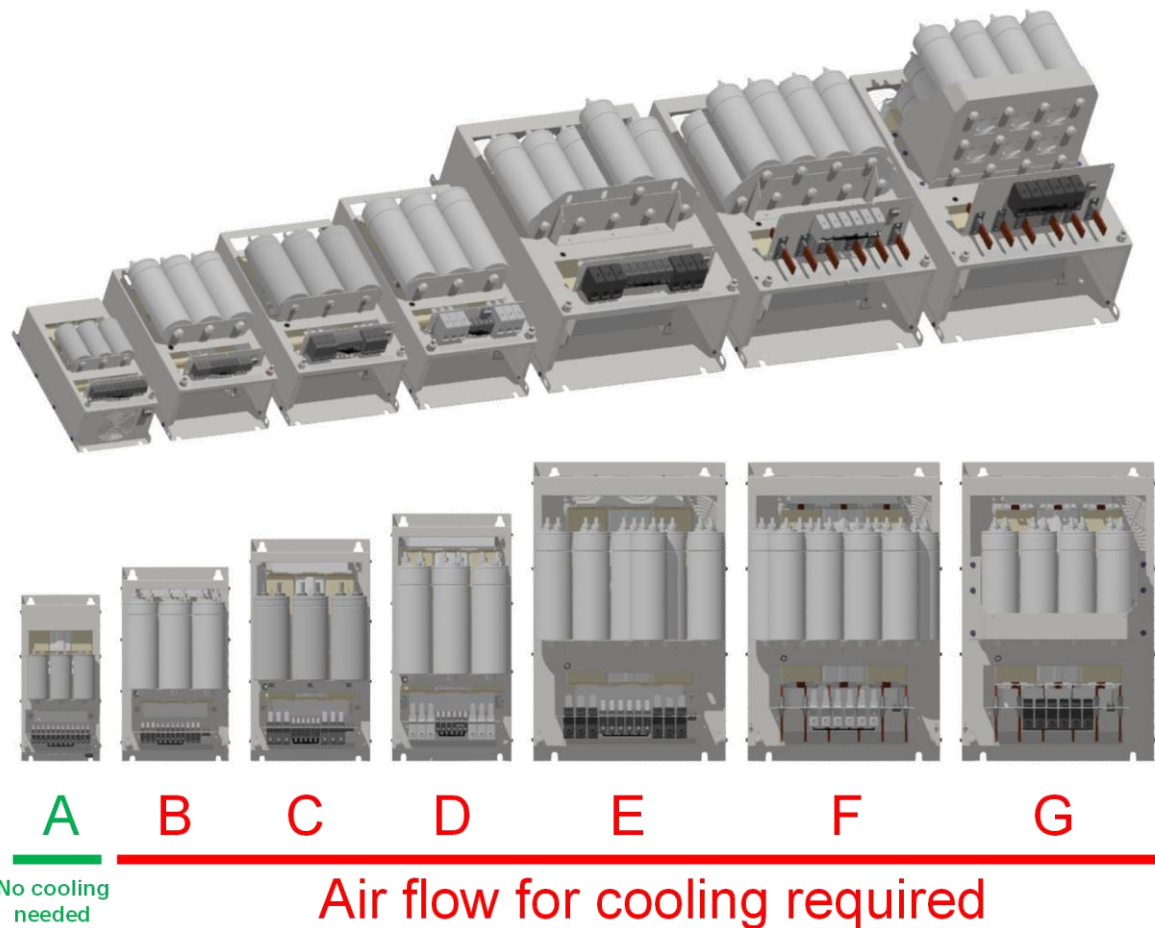

Figure 3 Overview of all IP00 frame sizes

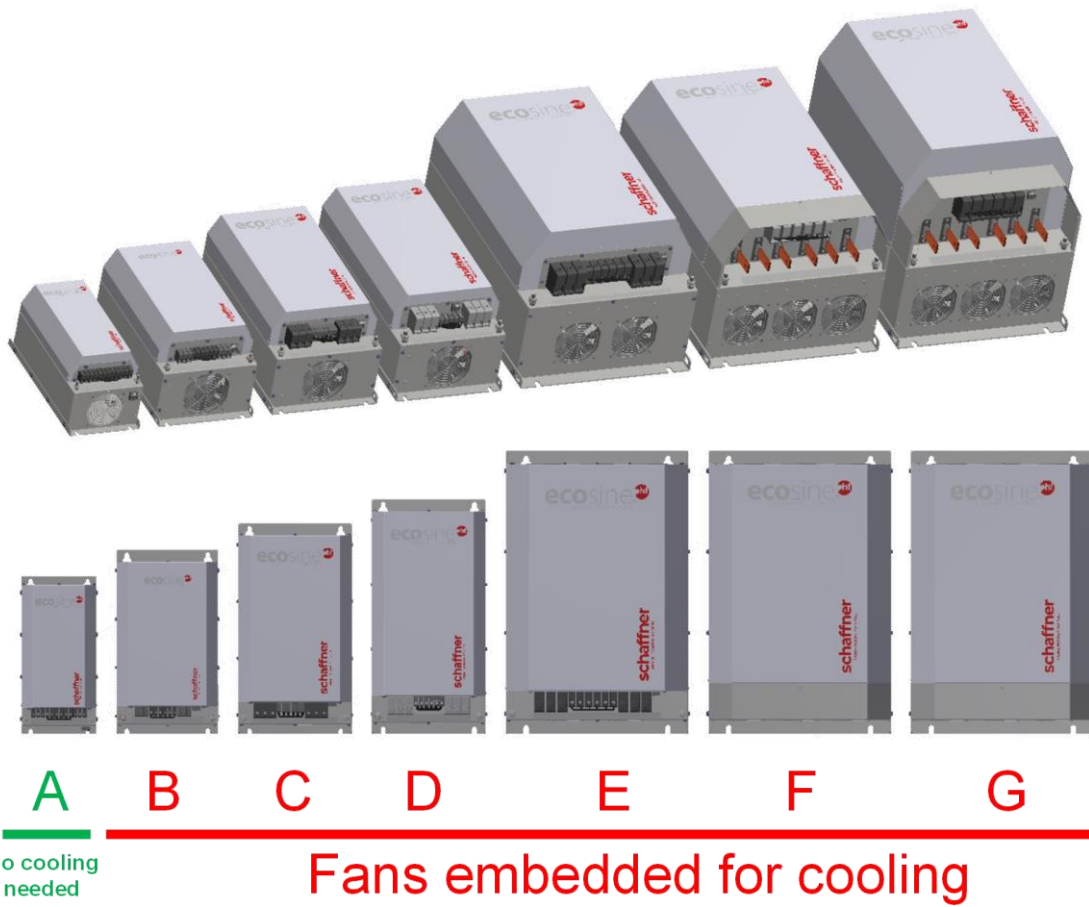

Figure 4 Overview of all IP20 frame sizes

3.8 Ecosine Flex filter footprint and dimensions

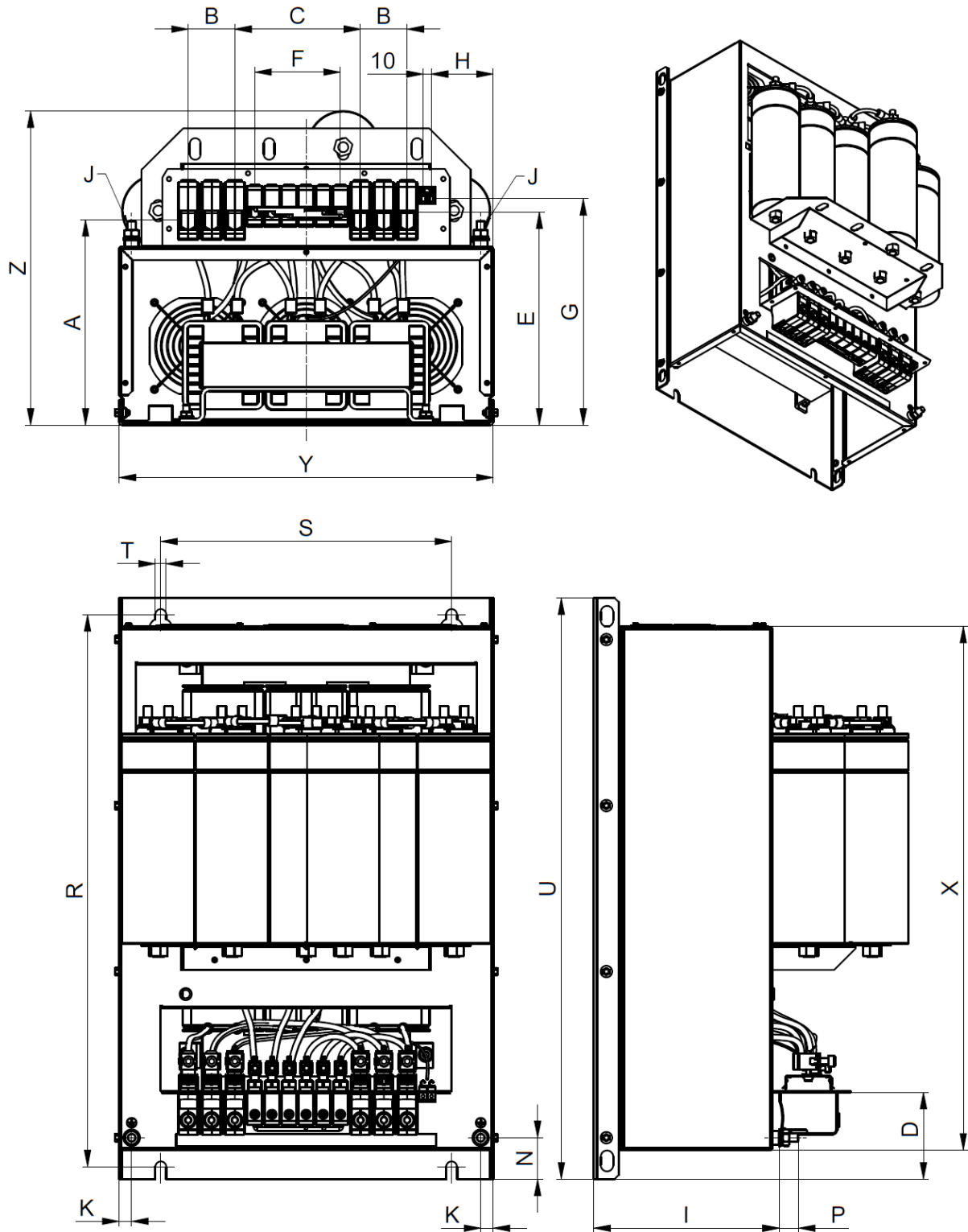

Figure 5 Frame size A to E in IP00

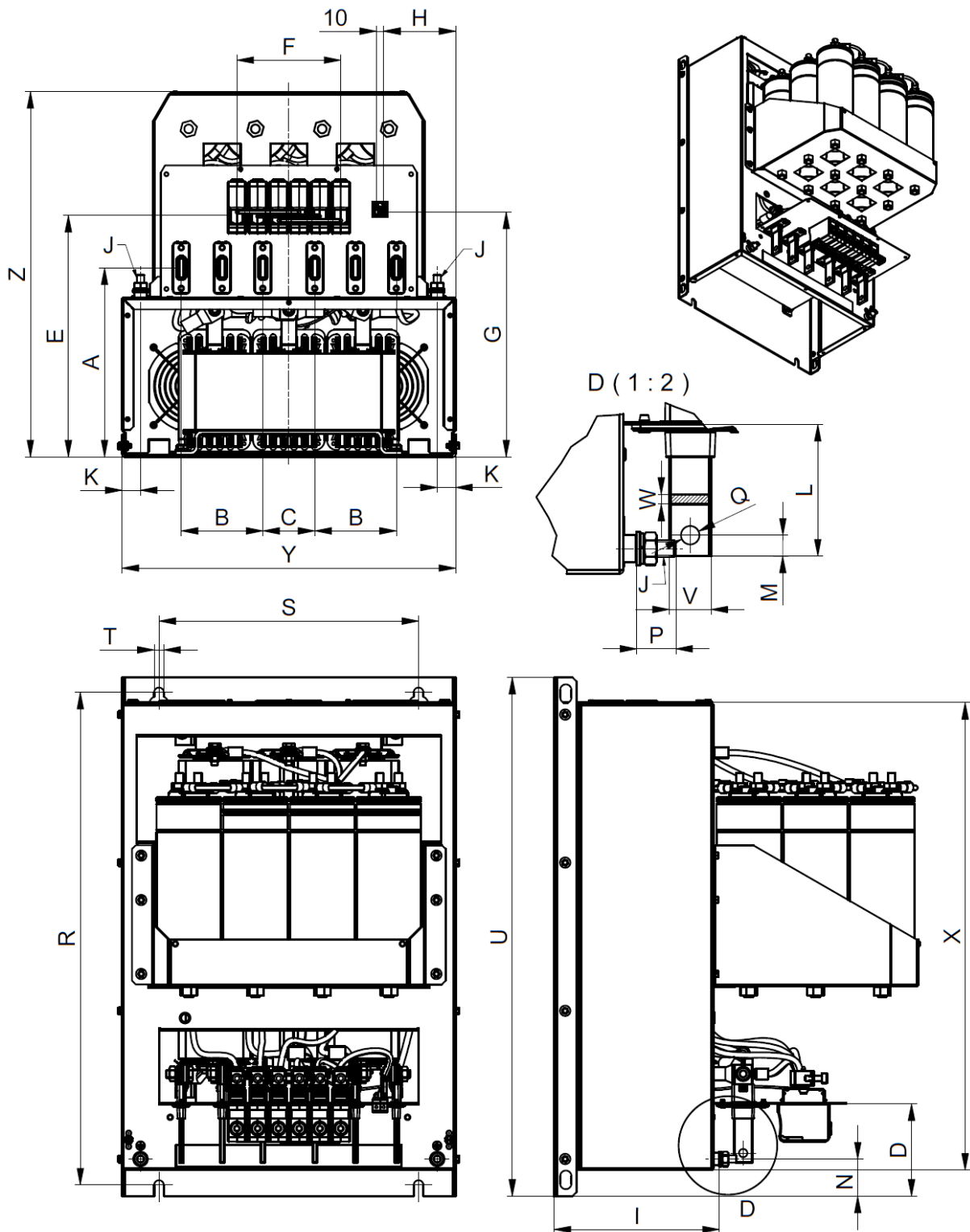

Figure 6 Frame size F and G in IP00

Figure 7 Dimensions of all IP00 versions

TYPE	A	B	C	D	E	F	G	H	I	K	L	M	N	P	Q	R	S	T	U	V	W	X	Y	Z	J	FS
FN3446-4-44-E0XXJXX	132	23	81	63	132	58	90	22	119	12			35	18		370	140	9	390			349	185	170	M6	A
FN3446-6-44-E0XXJXX	132	23	81	63	132	58	90	22	119	12			35	18		370	140	9	390			349	185	170	M6	A
FN3446-8-44-E0XXJXX	132	23	81	63	132	58	90	22	119	12			35	18		370	140	9	390			349	185	170	M6	A
FN3446-11-33-E0XXJXX	161	24	82	68	161	58	165	49	146	15			39	21		435	200	11	455			402	250	220	M8	B
FN3446-15-33-E0XXJXX	161	24	82	68	161	58	165	49	146	15			39	21		435	200	11	455			402	250	220	M8	B
FN3446-19-33-E0XXJXX	161	24	82	68	161	58	165	49	146	15			39	21		435	200	11	455			402	250	220	M8	B
FN3446-22-33-E0XXJXX	161	24	82	68	161	58	165	49	146	15			39	21		435	200	11	455			402	250	220	M8	B
FN3446-30-34-E0XXJXX	176	38	89	78	179	58	188	43	154	15			40	21		500	225	11	520			467	280	238	M8	C
FN3446-37-34-E0XXJXX	176	38	89	78	179	58	188	43	154	15			40	21		500	225	11	520			467	280	238	M8	C
FN3446-45-35-E0XXJXX	178	42	98	93	165	64	198	115	156	15			44	23		555	225	11	580			522	280	238	M10	D
FN3446-55-35-E0XXJXX	178	42	98	93	165	64	198	115	156	15			44	23		555	225	11	580			522	280	238	M10	D
FN3446-75-40-E0XXJXX	247	56	151	105	257	103	273	74	223	15			50	23		665	350	13	700			631	450	380	M10	E
FN3446-90-40-E0XXJXX	247	56	151	105	257	103	273	74	223	15			50	23		665	350	13	700			631	450	380	M10	E
FN3446-110-40-E0XXJXX	247	56	151	105	257	103	273	74	223	15			50	23		665	350	13	700			631	450	380	M10	E
FN3446-132-99-E0XXJXX	255	110	70	125	313	140	325	97	223	25	79	13	50	23	11	665	350	13	700	25	6	631	450	380	M10	F
FN3446-160-99-E0XXJXX	255	110	70	125	313	140	325	97	223	25	79	13	50	23	11	665	350	13	700	25	6	631	450	380	M10	F
FN3446-200-99-E0XXJXX	255	110	70	125	326	140	325	97	223	25	79	13	50	23	11	665	350	13	700	25	6	631	450	495	M10	G
FN3458-5-44-E0XXJXX	132	23	81	63	132	58	90	22	119	12			35	18		370	140	9	390			349	185	170	M6	A
FN3458-8-44-E0XXJXX	132	23	81	63	132	58	90	22	119	12			35	18		370	140	9	390			349	185	170	M6	A
FN3458-10-44-E0XXJXX	132	23	81	63	132	58	90	22	119	12			35	18		370	140	9	390			349	185	170	M6	A
FN3458-15-33-E0XXJXX	161	24	82	68	161	58	165	49	146	15			39	21		435	200	11	455			402	250	220	M8	B
FN3458-20-33-E0XXJXX	161	24	82	68	161	58	165	49	146	15			39	21		435	200	11	455			402	250	220	M8	B
FN3458-25-33-E0XXJXX	161	24	82	68	161	58	165	49	146	15			39	21		435	200	11	455			402	250	220	M8	B
FN3458-30-33-E0XXJXX	161	24	82	68	161	58	165	49	146	15			39	21		435	200	11	455			402	250	220	M8	B
FN3458-40-34-E0XXJXX	176	38	89	78	179	58	188	43	154	15			40	21		500	225	11	520			467	280	238	M8	C
FN3458-50-34-E0XXJXX	176	38	89	78	179	58	188	43	154	15			40	21		500	225	11	520			467	280	238	M8	C
FN3458-60-35-E0XXJXX	178	42	98	93	165	64	198	115	156	15			44	23		555	225	11	580			522	280	238	M10	D
FN3458-75-35-E0XXJXX	178	42	98	93	165	64	198	115	156	15			44	23		555	225	11	580			522	280	238	M10	D
FN3458-100-40-E0XXJXX	247	56	151	105	257	103	273	74	223	15			50	23		665	350	13	700			631	450	380	M10	E
FN3458-125-40-E0XXJXX	247	56	151	105	257	103	273	74	223	15			50	23		665	350	13	700			631	450	380	M10	E
FN3458-150-40-E0XXJXX	247	56	151	105	257	103	273	74	223	15			50	23		665	350	13	700			631	450	380	M10	E
FN3458-200-99-E0XXJXX	255	110	70	125	313	140	325	97	223	25	79	13	50	23	11	665	350	13	700	25	6	631	450	380	M10	F
FN3458-250-99-E0XXJXX	255	110	70	125	313	140	325	97	223	25	79	13	50	23	11	665	350	13	700	25	6	631	450	380	M10	F
FN3458-300-99-E0XXJXX	255	110	70	125	326	140	325	97	223	25	79	13	50	23	11	665	350	13	700	25	6	631	450	495	M10	G

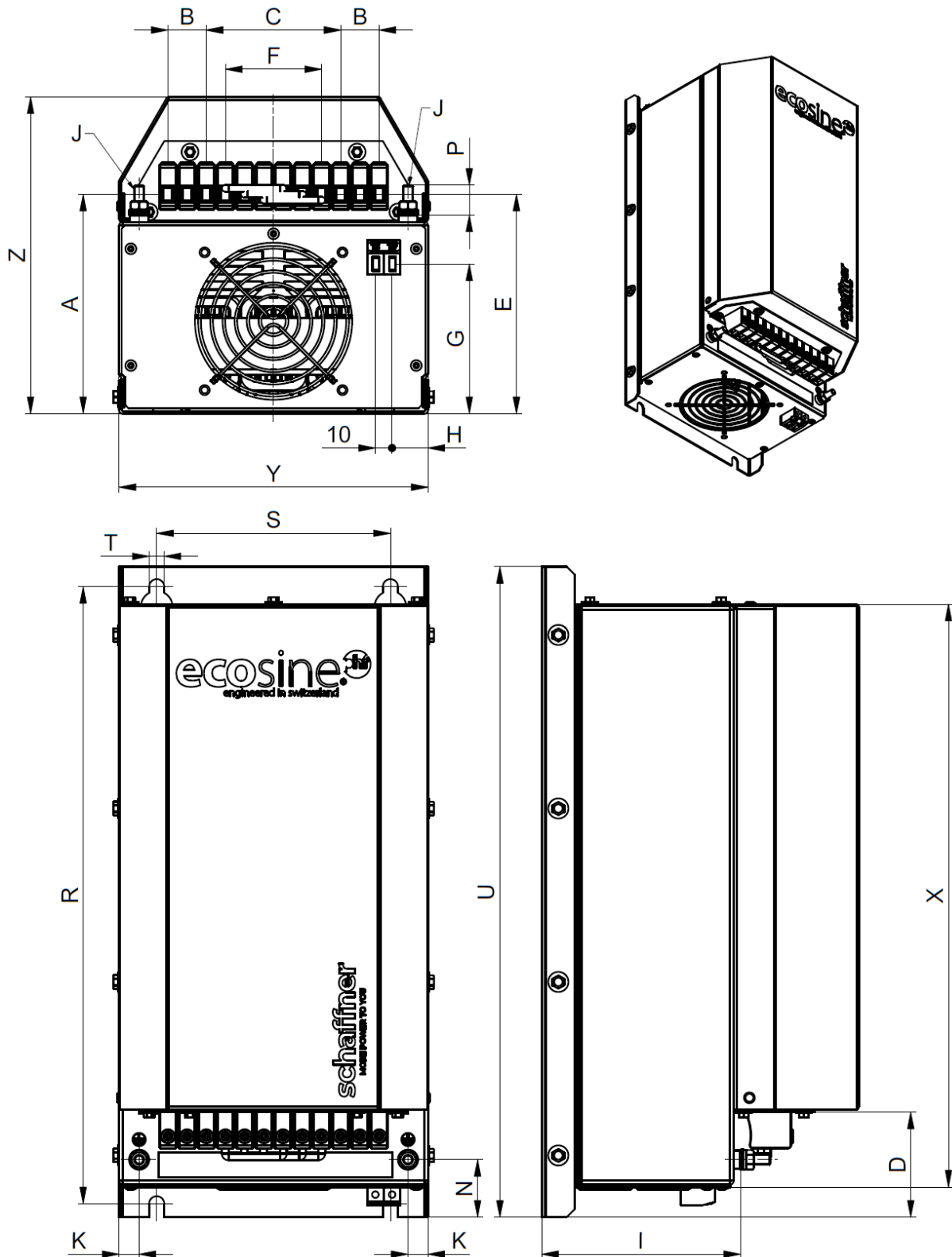

Figure 8 Frame size A to E in IP20

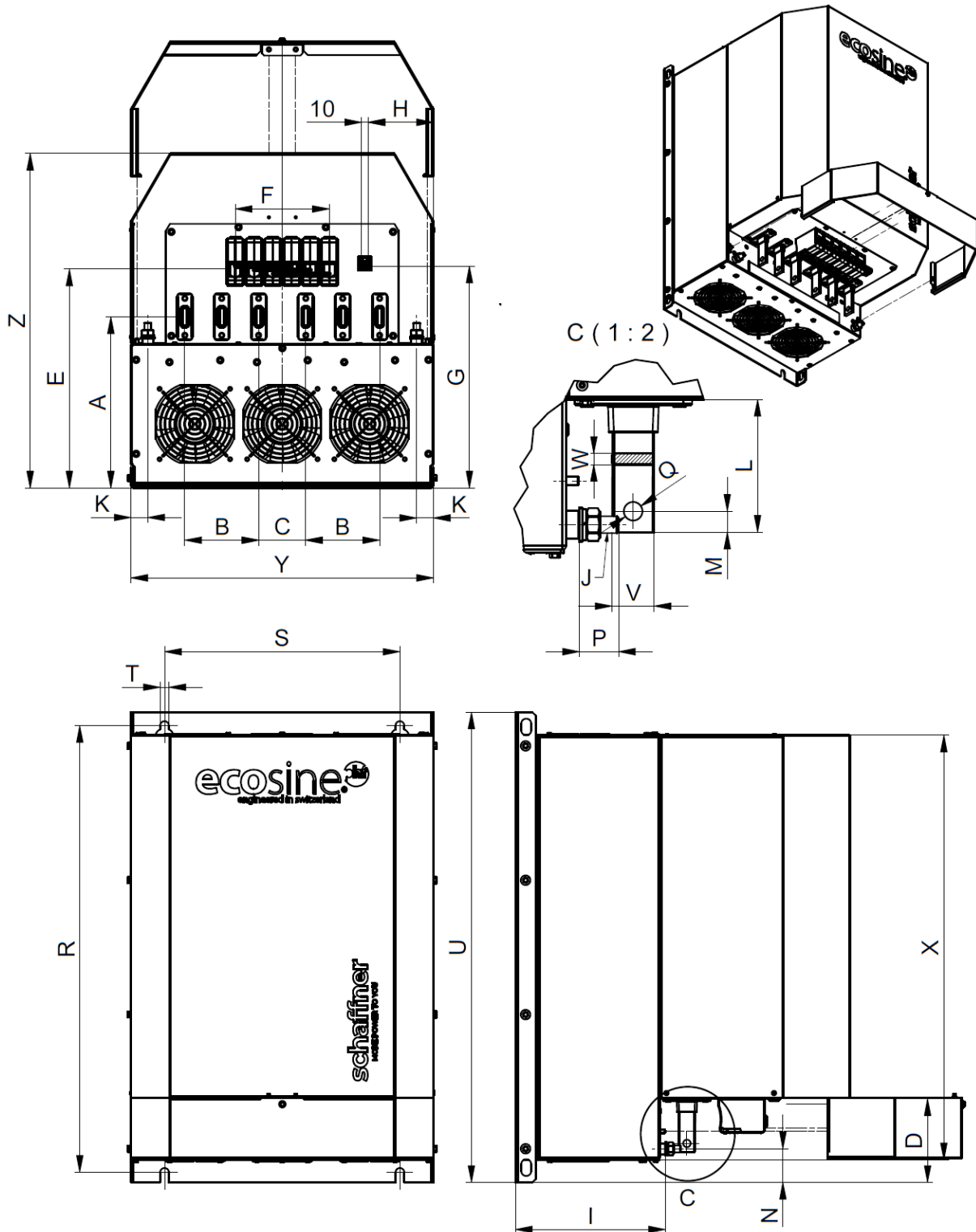

Figure 9 Frame size F and G in IP20

Figure 10 Dimensions of all IP20 versions

TYPE	A	B	C	D	E	F	G	H	I	K	L	M	N	P	Q	R	S	T	U	V	W	X	Y	Z	J	FS
FN3446-4-44-E2XXJXX	132	23	81	63	132	58	90	22	119	12			35	18		370	140	9	390			350	185	190	M6	A
FN3446-6-44-E2XXJXX	132	23	81	63	132	58	90	22	119	12			35	18		370	140	9	390			350	185	190	M6	A
FN3446-8-44-E2XXJXX	132	23	81	63	132	58	90	22	119	12			35	18		370	140	9	390			350	185	190	M6	A
FN3446-11-33-E2FAJXX	161	24	82	68	161	58	165	49	146	15			39	21		435	200	11	455			403	250	230	M8	B
FN3446-15-33-E2FAJXX	161	24	82	68	161	58	165	49	146	15			39	21		435	200	11	455			403	250	230	M8	B
FN3446-19-33-E2FAJXX	161	24	82	68	161	58	165	49	146	15			39	21		435	200	11	455			403	250	230	M8	B
FN3446-22-33-E2FAJXX	161	24	82	68	161	58	165	49	146	15			39	21		435	200	11	455			403	250	230	M8	B
FN3446-30-34-E2FAJXX	176	38	89	78	179	58	188	43	154	15			40	21		500	225	11	520			468	280	248	M8	C
FN3446-37-34-E2FAJXX	176	38	89	78	179	58	188	43	154	15			40	21		500	225	11	520			468	280	248	M8	C
FN3446-45-35-E2FAJXX	178	42	98	93	165	64	198	115	156	15			44	23		555	225	11	580			523	280	248	M10	D
FN3446-55-35-E2FAJXX	178	42	98	93	165	64	198	115	156	15			44	23		555	225	11	580			523	280	248	M10	D
FN3446-75-40-E2FAJXX	247	56	151	105	257	103	273	74	223	15			50	23		665	350	13	700			633	450	385	M10	E
FN3446-90-40-E2FAJXX	247	56	151	105	257	103	273	74	223	15			50	23		665	350	13	700			633	450	385	M10	E
FN3446-110-40-E2FAJXX	247	56	151	105	257	103	273	74	223	15			50	23		665	350	13	700			633	450	385	M10	E
FN3446-132-99-E2FAJXX	255	110	70	125	313	140	325	97	223	25	79	13	50	23	11	665	350	13	700	25	6	633	450	385	M10	F
FN3446-160-99-E2FAJXX	255	110	70	125	313	140	325	97	223	25	79	13	50	23	11	665	350	13	700	25	6	633	450	385	M10	F
FN3446-200-99-E2FAJXX	255	110	70	125	326	140	325	97	223	25	79	13	50	23	11	665	350	13	700	25	6	633	450	498	M10	G
FN3458-5-44-E2XXJXX	132	23	81	63	132	58	90	22	119	12			35	18		370	140	9	390			350	185	190	M6	A
FN3458-8-44-E2XXJXX	132	23	81	63	132	58	90	22	119	12			35	18		370	140	9	390			350	185	190	M6	A
FN3458-10-44-E2XXJXX	132	23	81	63	132	58	90	22	119	12			35	18		370	140	9	390			350	185	190	M6	A
FN3458-15-33-E2FAJXX	161	24	82	68	161	58	165	49	146	15			39	21		435	200	11	455			403	250	230	M8	B
FN3458-20-33-E2FAJXX	161	24	82	68	161	58	165	49	146	15			39	21		435	200	11	455			403	250	230	M8	B
FN3458-25-33-E2FAJXX	161	24	82	68	161	58	165	49	146	15			39	21		435	200	11	455			403	250	230	M8	B
FN3458-30-33-E2FAJXX	161	24	82	68	161	58	165	49	146	15			39	21		435	200	11	455			403	250	230	M8	B
FN3458-40-34-E2FAJXX	176	38	89	78	179	58	188	43	154	15			40	21		500	225	11	520			468	280	248	M8	C
FN3458-50-34-E2FAJXX	176	38	89	78	179	58	188	43	154	15			40	21		500	225	11	520			468	280	248	M8	C
FN3458-60-35-E2FAJXX	178	42	98	93	165	64	198	115	156	15			44	23		555	225	11	580			523	280	248	M10	D
FN3458-75-35-E2FAJXX	178	42	98	93	165	64	198	115	156	15			44	23		555	225	11	580			523	280	248	M10	D
FN3458-100-40-E2FAJXX	247	56	151	105	257	103	273	74	223	15			50	23		665	350	13	700			633	450	385	M10	E
FN3458-125-40-E2FAJXX	247	56	151	105	257	103	273	74	223	15			50	23		665	350	13	700			633	450	385	M10	E
FN3458-150-40-E2FAJXX	247	56	151	105	257	103	273	74	223	15			50	23		665	350	13	700			633	450	385	M10	E
FN3458-200-99-E2FAJXX	255	110	70	125	313	140	325	97	223	25	79	13	50	23	11	665	350	13	700	25	6	633	450	385	M10	F
FN3458-250-99-E2FAJXX	255	110	70	125	313	140	325	97	223	25	79	13	50	23	11	665	350	13	700	25	6	633	450	385	M10	F
FN3458-300-99-E2FAJXX	255	110	70	125	326	140	325	97	223	25	79	13	50	23	11	665	350	13	700	25	6	633	450	498	M10	G

3.9 Filter performance

Ecosine Flex Passive Harmonic Filters performance dependent on several conditions. The first condition is the size of the DC-Link choke in the drive.

For 6-pulse diode rectifiers drive with $\geq 4\%$ DC-Link choke: the typical performance achieves a THDi of 10% or better.

For 6-pulse diode rectifiers drive with $< 4\%$ DC-Link choke or without DC-Link choke: the typical performance achieves a THDi of 15% or better.

This typical performance is fulfilled under the following conditions:

- Filter is operated at the rated voltage and power.
- THDv $< 2\%$, line voltage unbalance $< 1\%$.

Ecosine Flex filter performance (THDi, power factor and U_{dc}) under different load conditions are shown in the following charts.

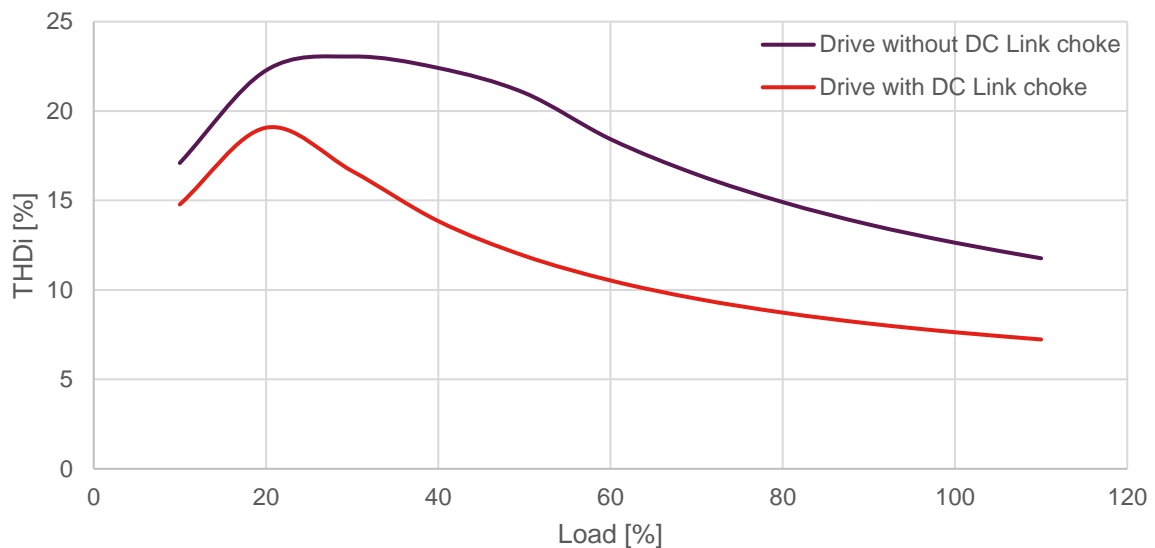

Figure 11 THDi vs. load (diode rectifier front-end)

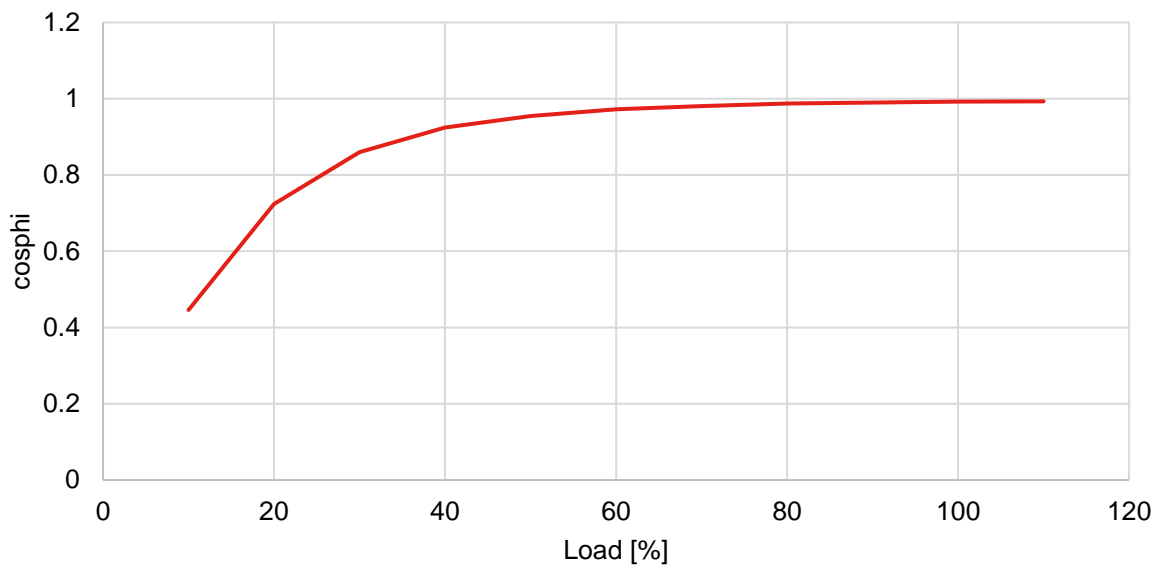

Figure 12 Power factor vs. load (diode rectifier front-end)

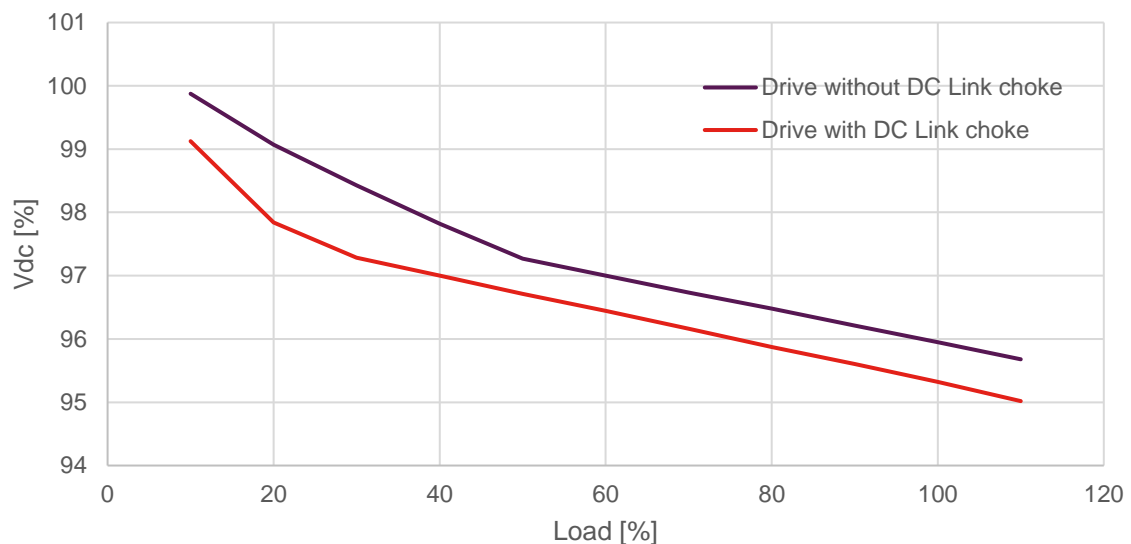

Figure 13 Drive dc-link voltage vs. load (diode rectifier front-end, with FN3446 series)

3.9.1 Additional considerations regarding the performances

3.9.1.1 SCR drives

THDi performance is not guaranteed for thyristor rectifier (often called SCR drives) application. The performance of the filter is dependent on the firing angle of the thyristors. The performance can be simulated using Schaffner PQS (see section 5).

3.10 Functional diagram

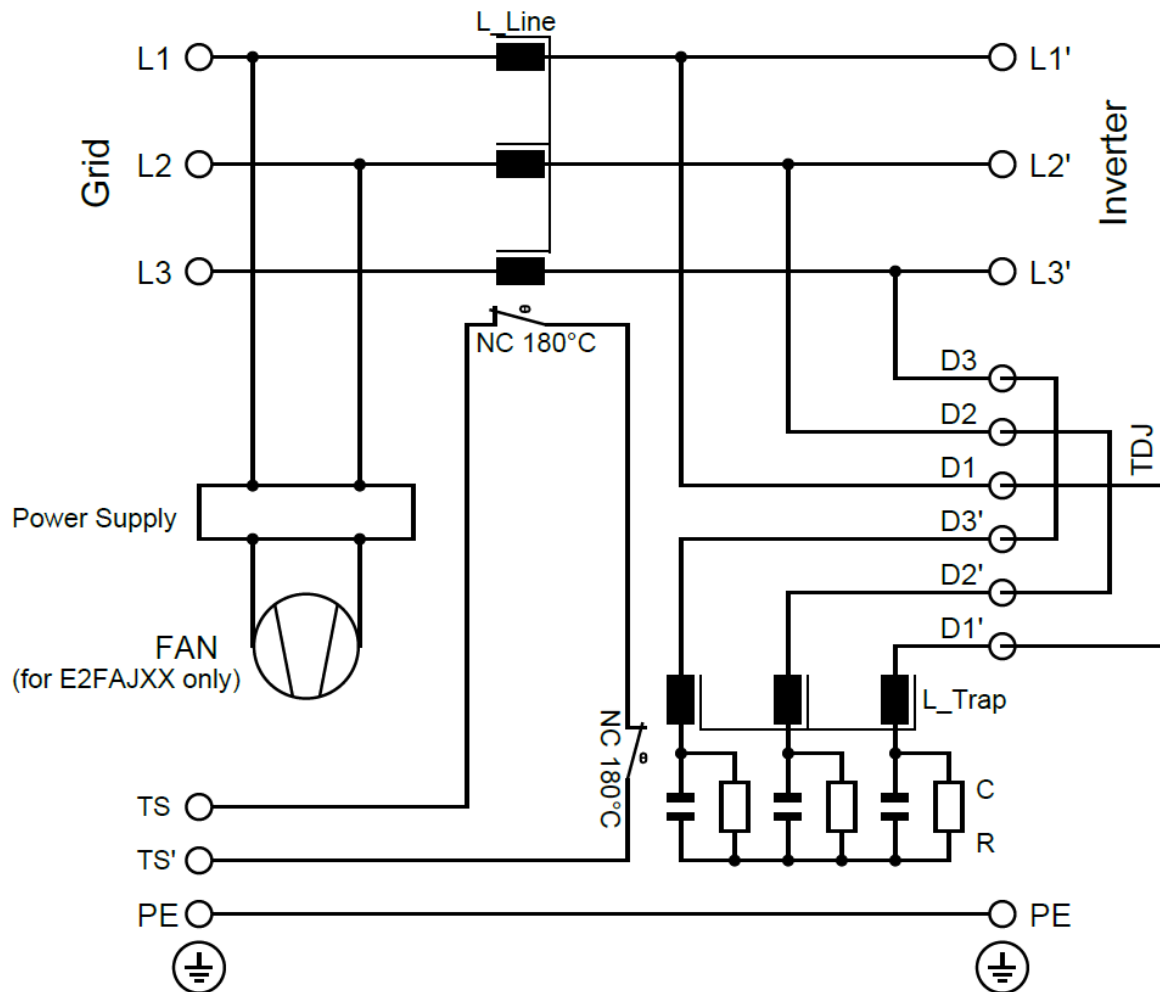

Filter terminals	Line L1/L2/L3	3 terminal blocks or bus bars
	Load L1'/L2'/L3'	3 terminal blocks or bus bars
	TS/TS'	Connecting terminals to thermal switch NC 180°C (UL-approved) to detect overload in chokes
	PE	Protective earth. Threaded stud with washer and nut
	TDJ D1, D2, D3 D1', D2', D3'	Trap Disconnect Jumper (TDJ) terminals. 3 couples of terminals that allow for the connection of an external contactor for load dependent disconnection of the trap circuit, if needed. At delivery, wire bridges are installed between the terminals of the TDJ for immediate operation of the filter without the use of a contactor.
Function blocks	Chokes L	Power magnetic components incl. temperature sensors
	Capacitors C	Power capacitors incl. discharge resistors
	Fan	Field replaceable fan for filter air cooling (E2FAJXX only)
	Power supply	Internally generate 24 V DC source for fan supply (E2FAJXX only)

4 Filter appearance and elements

The very compact and neat design of Ecosine Flex Passive Harmonic Filters is realized by a two-stage construction. The filter constructions of all frame sizes are identical. The general design is shown in Figure 14.

There are trap capacitor C_t , trap disconnect jumper, power terminal and fan inlet visible on the upper-stage. The design and construction of the lower-stage is shown in Figure 15. The line choke L_i and trap choke L_t are constructed on the base plate, which contains screw holes for wall mounting.

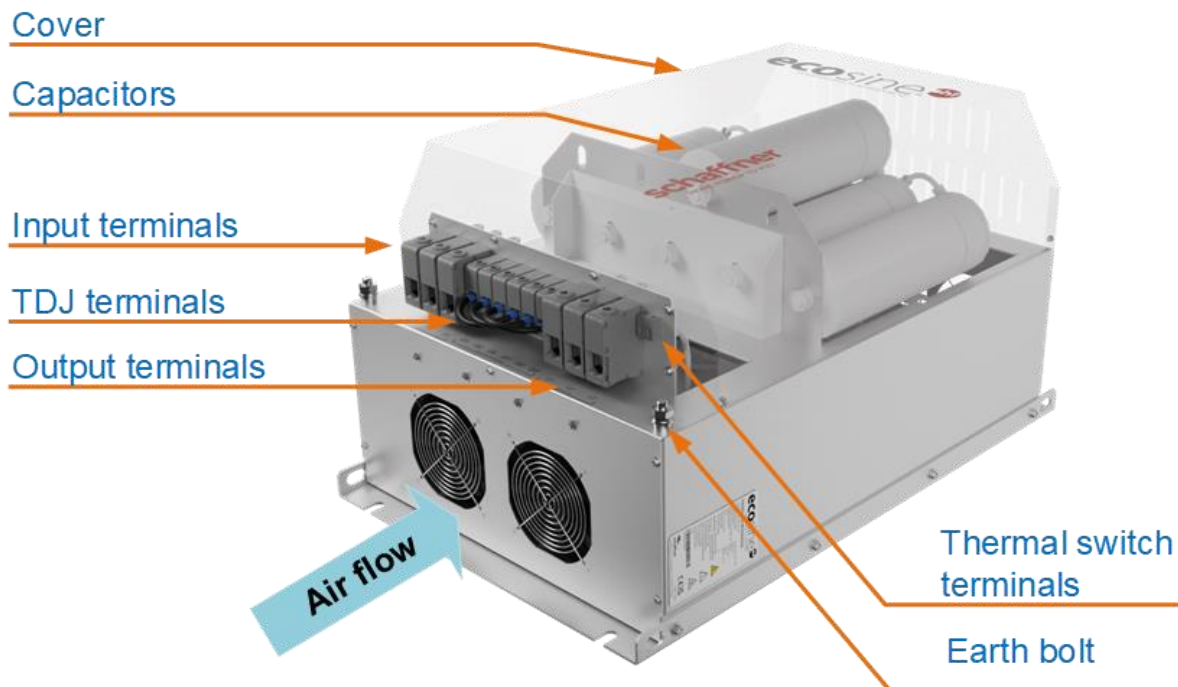

Figure 14 Design of Ecosine Flex filter (Type E0XXJXX, frame size D): Upper-stage

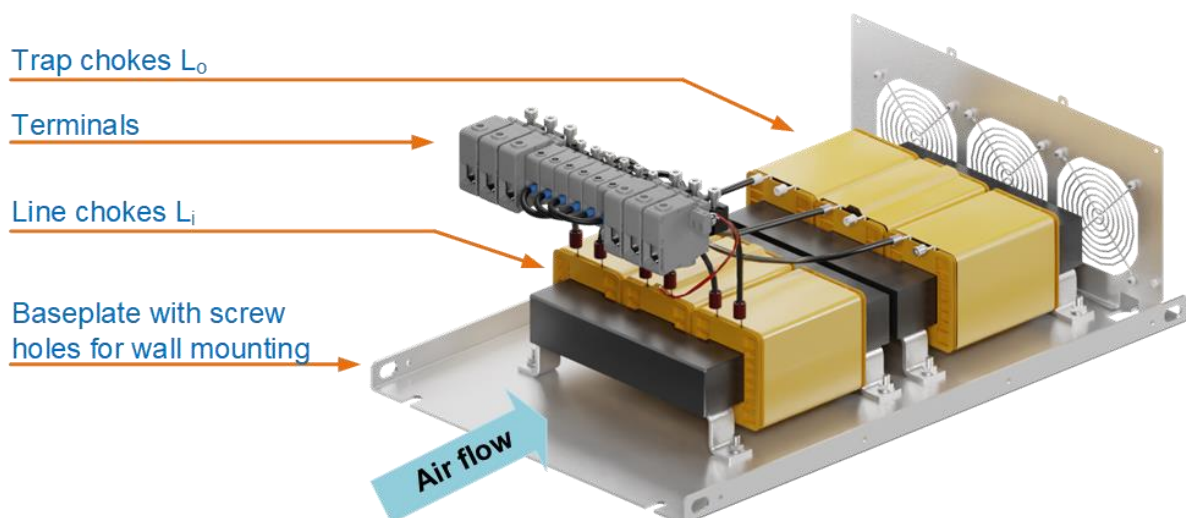
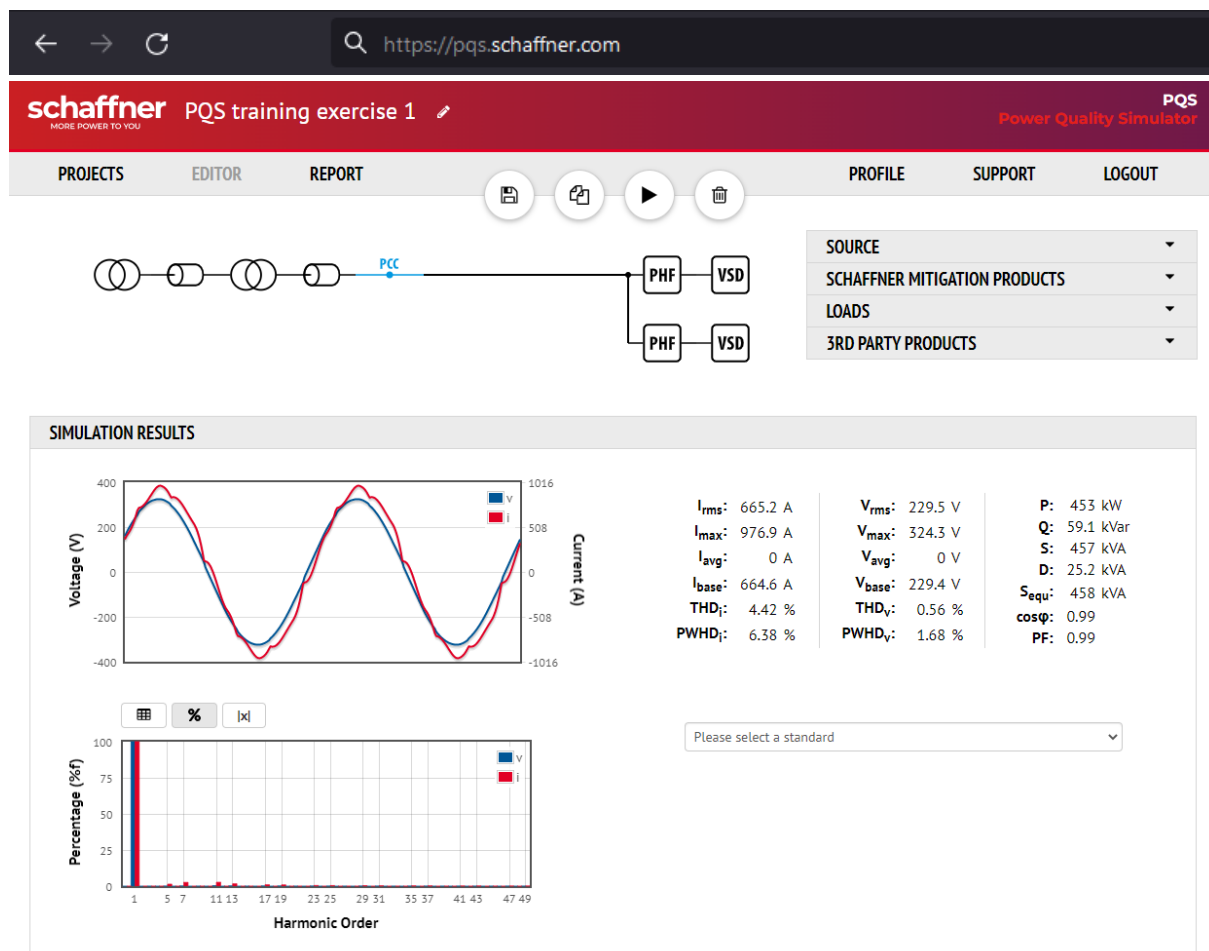

Figure 15 Lower-stage of Ecosine Flex filter (Type E0XXJXX, frame size D): lower-stage

5 Performance estimation using SchaffnerPQS

Ecosine Flex Passive Harmonic Filters can be simulated with the Schaffner Power Quality Simulator, SchaffnerPQS, at pqs.schaffner.com.

By using SchaffnerPQS, users can easily simulate and estimate system performance, taking into account the most important design requirements and system's boundary conditions.



6 Filter application

Ecosine Flex Passive Harmonic Filters are designed to mitigate harmonic current of non-linear loads, particularly of three-phase diode-type rectifiers. Contrary to “bus-applied or PCC (Point of Common Coupling)” filters, which are being installed e.g. at the main feeder, they are specifically designed to be used with either an individual non-linear load or two of the same load connecting in parallel.

One advantage of load-applied filtering is the fact that the upstream power (relative to the harmonic filter) is clean, i.e. unloaded by the harmonics. This can be of vital importance when the same power bus supplies both motor drives and sensitive loads. Ecosine Flex Passive Harmonic Filters are also suitable for paralleling lower power non-linear loads on a higher power harmonic filter to improve overall system cost. In this case the total expected load power of all connected drives must match the filter.

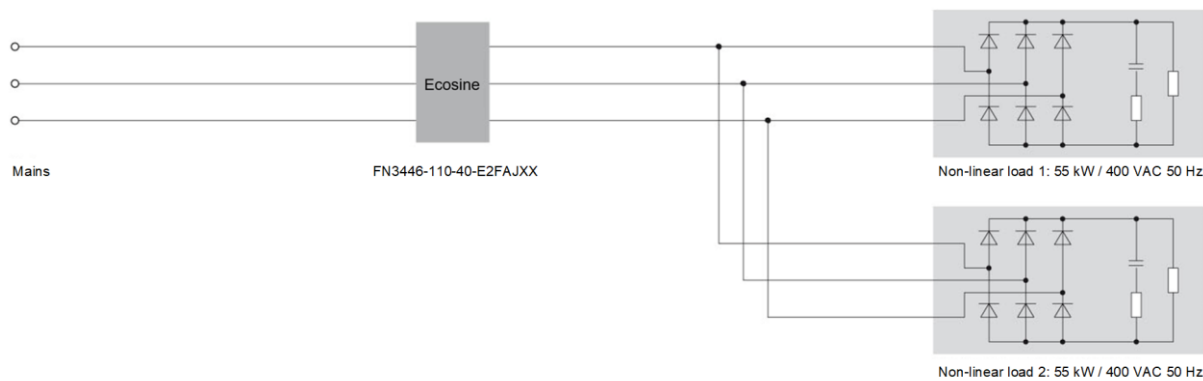

If the expected input power exceeds the rating of the largest available Ecosine Flex filter, the Ecosine Max Passive Harmonic Filter series (FN347x and FN348x) are more suitable, starting at 250 kW and up to 500 kW.

7 Filter installation

Please follow the simple steps below to ensure a safe and reliable filter function for many years. Please always follow the general safety and installation guidelines provided within this document as well as relevant local, national or international standards that are applicable. Note that the following installation steps are applicable for both IP 00 and IP 20 filter versions.

7.1 Step 1: Visual inspection

All Schaffner Ecosine Flex Passive Harmonic Filters have undergone rigorous testing before they left our ISO 9001:2015 certified factories. They are packaged with great care in a sturdy container for international shipment.

However, carefully inspect the shipping container for damage that may have occurred in transit. Then unpack the filter and carefully inspect for any signs of damage. Keep the shipping container for future transportation of the filter.

In the case of damage, please immediately file a claim with the freight forwarder involved and contact your local Schaffner partner for support. Under no circumstances install and energize a filter with visible transportation damage.

If the filter is not going to be put in service upon receipt, after inspection, store it in its original container in a clean, dry location, free of dust and chemicals and with respect to named temperature limits, see section 3.1.

7.2 Step 2: Mounting

Ecosine Flex Passive Harmonic Filters are best installed as close as possible to the non-linear load. Ideally, they are mounted next to the rectifier or motor drive inside the electrical cabinet or at least in the same control room.

All Ecosine Flex Passive Harmonic Filters FN3446 and FN3458 are designed for wall-mounting installation.



It is forbidden to mount Ecosine Flex Passive Harmonic Filters in flat position or any other position than wall-mounting in upward position (cable entry from the bottom) as stated in this manual.

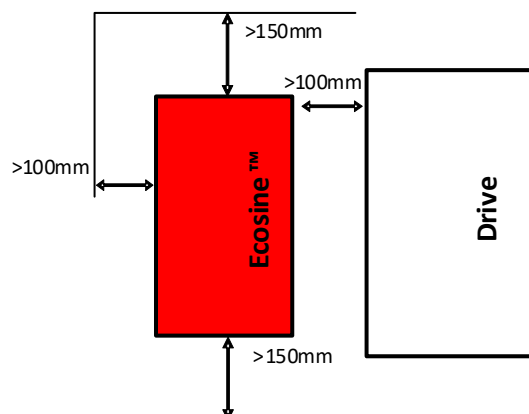

7.2.1 Fixation

Screw hole positions for wall mounted filters (as indicated in Table 10):

Table 10 Dimensions of frame sizes

Frame	Drill pattern [mm]		
	R	S	T
A	370	140	9
B	435	200	11
C	500	225	11
D	555	225	11
E	665	350	13
F	665	350	13
G	665	350	13

All dimensions in mm; 1 inch = 25.4mm

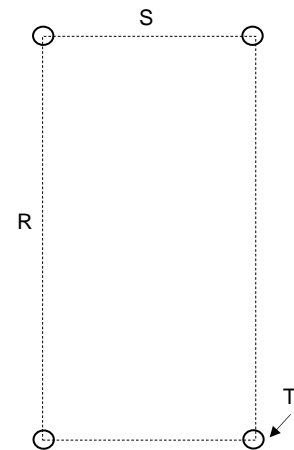

7.2.2 Screws and bolts selection

Screw selection: Schaffner recommends zinc coated hex ribbed flange steel bolts. Respect filters weight for appropriate choice of screws! Head diameters must not exceed these dimensions:

M6: $d \leq 14.2$ mm, M10: $d \leq 21.2$ mm

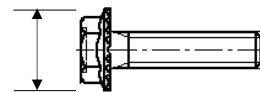

7.2.3 Filter placement

1. Set screws loose into wall, leave 5mm distance from head to wall.
2. Lift filter with appropriate crane, smallest types (up to 25 kg) may be lifted manually by two persons.
3. Place filter first onto lower screws...
4. ...then position it through backplane head openings on upper screws.
5. Fix screws with appropriate torque (depending upon the material of the back plane and local standards).

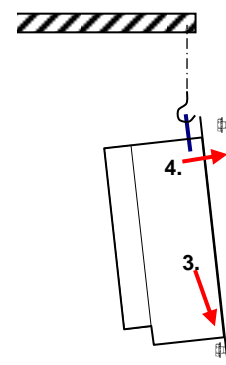

7.3 Step 3: Wiring

7.3.1 Verify safe disconnection of all line side power.

Consult your local safety instructions.



7.3.2 Carefully connect protective earth (PE) wire to adequate earth potential close to Ecosine filter.

Use a wire diameter of equal or bigger size as foreseen for line/load side power cables – according to your local codes and safety instructions.

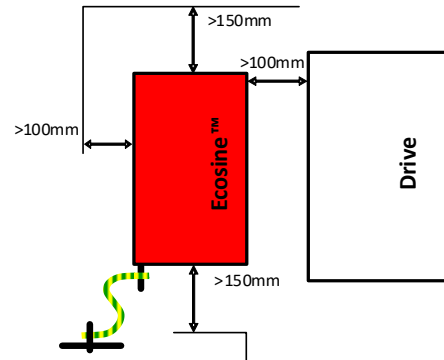

7.3.3 Connect PE cable of Ecosine filter

with appropriate cable lug to threaded stud.

torque M6:	4 Nm
torque M8:	9 Nm
torque M10:	19 Nm

7.3.4 Connect Ecosine load side terminals L1', L2', L3' to respective motor drive or rectifier inputs.

The third part of Ecosine Flex designation is a number containing two digits, i.e. FN3446-11-33, which indicates power terminal type.

See section 3.4 for the recommended wire size and torque. Use stranded copper wire with a temperature rating of 75°C or higher.

Ecosine Flex filters equipped with bus bar terminal (type -99) require additional pre-caution when installing the cables to reach IP20 protection level on the system. An appropriate shrinking sleeve must be inserted around the cable ending to cover all exposed part of the cable lug and terminal.

7.3.5 Use wired trap circuit or install external capacitive current control.

Ecosine Flex are delivered with TDJ option, terminals D1- D1', D2- D2' and D3- D3' are delivered with installed jumpers. When interconnected via an external capacitor contactor (not supplied by Schaffner) they allow for load dependent disconnection of the trap circuit, if needed. Thus capacitive current can be minimized for low load operation. Estimation of required contactor size: see box to the right.



The use of contactor for capacitor switching is required. Otherwise, the capacitor and switch lifetime may be strongly reduced.

Contactor performance estimate:

Example: FN3446-55-35

The nominal power rating in kW multiples by 50% and the ratio between the grid voltage and the nominal voltage (400 V for FN3446, 480 V for FN3458) is the approximate reactive power.

Contactor rating =

$$55 \text{ kW} * 50\% * \frac{V_{grid}}{V_{nom}} =$$

$$55 \text{ kW} * 50\% * \frac{400V}{400V} = 27.5 \text{ kVAR}$$

7.3.6 Connect monitor switch TS- TS'

The monitor switch is a relay contact, which is open in ALARM state. It is constituted by a thermal switch NC 180°C (UL-approved) to detect overload of chokes. It may either be used to remotely disconnect the drive's load via respective input of drive control (check drive manual) or as alarm sensor for system control unit.



An engaged monitor switch must lead to immediate load shutdown and investigation of the problem.

7.3.7 Connect Ecosine line side terminals L1, L2, L3 to power input protection (current limiting fuses – see below).

The third part of Ecosine Flex designation is a number containing two digits, i.e. FN3446-11-33, which indicates power terminal type.

See section 3.4 for the recommended wire size and torque. Use stranded copper wire with a temperature rating of 75°C or higher.

Ecosine Flex filters equipped with bus bar terminal (type -99) require additional pre-caution when installing the cables to reach IP20 protection level on the system. An appropriate shrinking sleeve must be inserted around the cable ending to cover all exposed part of the cable lug and terminal.

7.3.8 Fuses

Ecosine Flex Passive Harmonic Filters need external over-current protection for compliance with UL/cUL standard. Fuses and associated fuse holders must be UL listed and rated for 100kA SCCR supplies. Table 11 and Table 12 show requested fuse current ratings for UL class J and, where UL compliance is not mandatory, for IEC class gG. The fuse rating is independent of the supply voltage.

In case of higher power load, Schaffner recommend using Ecosine Max Passive Harmonic Filters, FN347x and FN348x series with rated load power up to 500 kW. If for any reason it is still preferred to use Ecosine Flex in parallel, a maximum of two identical filters can be used.

In such system each filter need a separate 3-phase line side fuse block, corresponding to the respective filter and according to Table 11 and Table 12. The drive's application manual may prescribe line-side fuse protection as well, which in this case either corresponds to the sum of the filter fuse ratings or, if lower, would request separate drive fuses at its input.

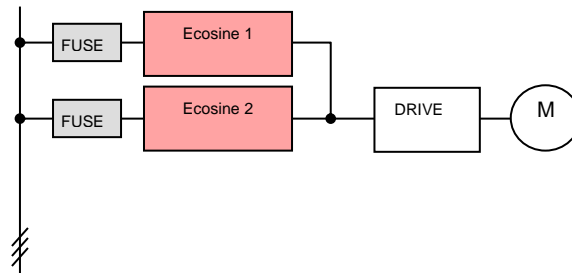

An application, having one Ecosine filtering harmonics of several drives, requires in any case line side fuse protection of the drives as well as the correct filter protection according to Table 11 and Table 12.

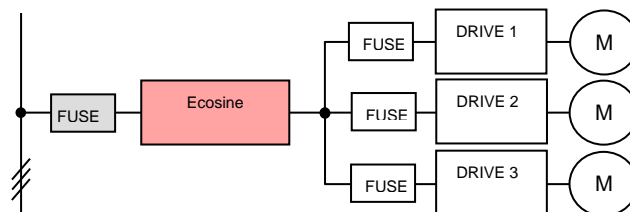

Table 11 Requested fuse current rating for UL class J and for IEC class gG

Ecosine Flex type FN3446	Fuse class J rated A	Fuse class gG rated A
FN3446-4-44	10	10
FN3446-6-44	15	10
FN3446-8-44	20	16
FN3446-11-33	25	20
FN3446-15-33	35	35
FN3446-19-33	40	35
FN3446-22-33	50	50
FN3446-30-34	75	63
FN3446-37-34	80	80
FN3446-45-35	100	100
FN3446-55-35	150	125
FN3446-75-40	175	160
FN3446-90-40	200	200
FN3446-110-40	250	224
FN3446-132-99	300	250
FN3446-160-99	350	300
FN3446-200-99	400	400

Table 12 Requested fuse current rating for UL class J

Ecosine Flex type FN3458	Fuse class J rated A
FN3458-5-44	7
FN3458-8-44	10
FN3458-10-44	15
FN3458-15-33	20
FN3458-20-33	30
FN3458-25-33	35
FN3458-30-33	40
FN3458-40-34	50
FN3458-50-34	60
FN3458-60-35	80
FN3458-75-35	90
FN3458-100-40	125
FN3458-125-40	150
FN3458-150-40	175
FN3458-200-99	250
FN3458-250-99	300
FN3458-300-99	400

8 Filter maintenance

Ecosine Flex Passive Harmonic Filters described in this manual are equipped with long life components that ensure a satisfactory function for many years under normal operating conditions. Any operation under extreme conditions such as over-temperatures, overvoltage situations, polluted environments etc. reduces the life expectancy. The following maintenance recommendations will help maximize filter lifetime.

Warnings:



High voltage potential is involved in the operation of this product. Always remove line side power before attempting to perform maintenance and let ample time elapse for the capacitors to discharge to safe levels (<42 V). Residual voltages are to be measured both line to line and line to earth.



Line side power must be disconnected prior to replacement of any part.

8.1 Maintenance schedule

Table 13 Maintenance schedule table

year	1	2	3	4	5	6	7	8	9	10	11	12
check and clean fan(s)	X	X	X	X	X	X	X	X	X	X	X	X
replace fan(s)					X					X		
check & tighten el. Connections ¹⁾	X	X	X	X	X	X	X	X	X	X	X	X
check el. values of capacitors		X		X		X		X		X		X
replace power capacitors										X		

¹⁾ Only external connections need to be checked.

8.2 Fan

Schaffner Ecosine Flex Passive Harmonic Filters are reliable low maintenance products. Many products like power supplies, inverters or motor drives utilize fans for forced cooling to minimize size and weight. Ecosine filters are designed with a similar temperature management concept and therefore, fans may have to be maintained and replaced at certain intervals to sustain the function and value of the product. Fans are 100% field replaceable without the need to uninstall and disconnect the filter.

Forced cooling devices are needed for the operation of some Schaffner Ecosine Flex Passive Harmonic Filters up to their nominal rating. Such cooling devices must be checked and cleaned regularly (if installed) to always ensure sufficient air flow.

Important: increased audible noise is a typical indicator of a fan that needs maintenance or replacement. This could also occur outside of a maintenance schedule.

Before cleaning or replacing the cooling devices, make sure to consult the recommended maintenance procedures and schedules of the supplier of the cooling device in use.

8.3 Power capacitors

The power capacitors supplied with the filter modules are high quality components with an expected lifetime of up to 100'000 hours (11 years). Nevertheless, their useful service life can be shortened by electrical or thermal stress beyond their specification.

Power capacitor damage may also be caused by severe abnormal supply voltage peaks (i.e. lightning – depending upon system protection), but may only be recognizable through the measurement of line side harmonics distortion. This may be checked with a modern energy meter or by regular checkup with a power quality analyzer. According to the above considerations, a 2-year inspection interval is advisable.

Note: an inspection should also be performed after extreme overvoltage situations in the system.

8.3.1 Note regarding the storage of capacitors

Up to 3 years-long storage, electrolytic capacitors can be operated without any restriction and the nominal voltage can be applied without any preliminary preparation. System reliability and lifetime expectancy are not affected.

On the other side, a longer (>3 years) storage of electrolytic capacitors without applying any voltage can weaken the dielectric properties because of dissolution processes. The electrolytic solution is aggressive, and it can affect and weaken the dielectric in the timeframe between production and product commissioning. These weak points are responsible for the higher leakage current shortly after the device is turned on.

The residual current of electrolytic capacitors depends upon time, voltage and temperature. The residual current increases after long storage without applying voltage.

The amplitude of resulting residual current during unit commissioning can be up to 10 times larger in a short term. The capacitor's residual current assumes the typical expected value at steady state for nominal voltage.

During commissioning after long storage, it is recommended to restore the dielectric characteristics by applying voltage progressively and with respect to the time frame the filters have been stored.

8.4 Electrical connections

Depending upon the environment and application, electrical connections, in particular threaded bolts and nuts, can degrade over time by means of losing their initial tightening torque. This holds true not only for the filter, but for any such joint within an electrical installation.

Therefore, Schaffner recommends checking and tightening all electrical connections during regular scheduled maintenance of the entire device that incorporates the filter. Checking of internal connections within the filters is not needed or if needed should only be conducted by a Schaffner service representative.

9 Trap circuit disconnect

The trap circuit disconnect feature allows to install a contactor for capacitor in the trap circuit with the purpose of reducing the capacitive current during low load operation, if needed. With permanently connected trap circuit, $\cos\phi$ vs. load shows following characteristics:

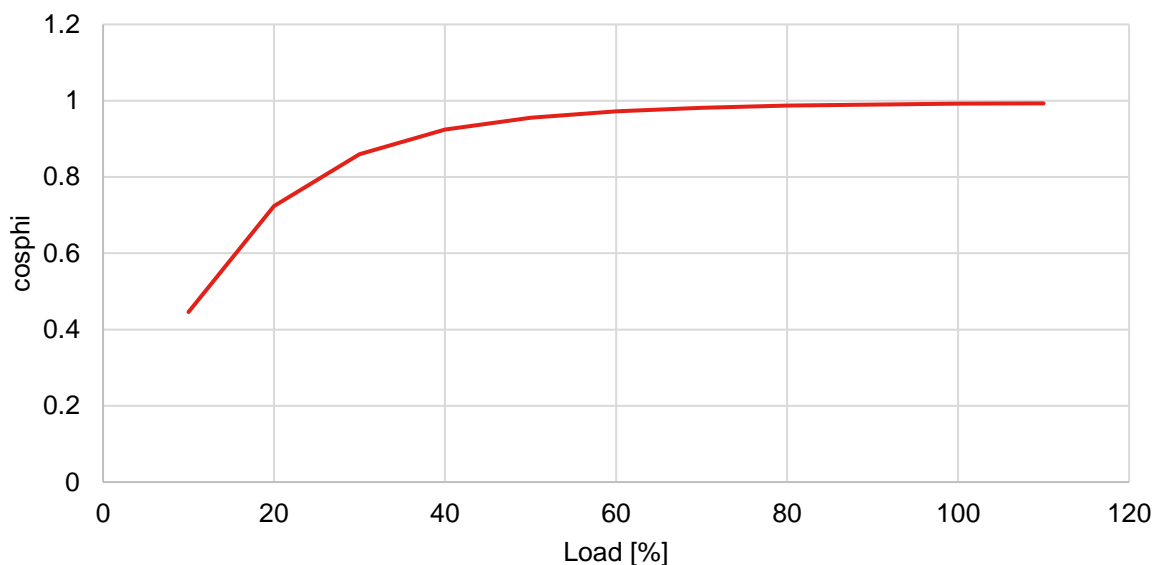

When the trap circuit is disconnected, $\cos(\phi)$ returns to ~ 0.98 . At the same time, the THDi will increase. This THDi increase may be negligible since absolute amplitude of harmonics are low at reduced load power compared to the amplitude at full load.

This feature requires external components (not part of Ecosine filter) and system functions for fully automated capacitive current control:

- Motor load (power factor) monitoring device
- Contactor for capacitor switching

A reduced load system status may be available as system controller output signal. In this case, only adequate driving of capacitor contactor must be assured.

Note: It is necessary to consider the overall concept of power factor correction. A system PFC correction unit with large capacitor banks may become obsolete or massively reduced, when harmonic filters are installed. In such cases it may not be necessary to use the trap circuit disconnect feature.

Recommended settings:

Schaffner recommends engaging and disengaging the trap circuit disconnect at following load levels:

Trap circuit state change to	Proposed load level
Disconnected	When load level drops under 10–15%
Connected	When load level rises above 20–25%

10 Troubleshooting

Schaffner Ecosine harmonic filters are high quality products and have undergone rigorous testing and qualification procedures. Every unit runs through suitable tests in our ISO 9001:2015 factories. Due to this reason no major issues need to be expected if the filter is installed, operated, and maintained as described in this document.

In the unlikely event of a problem, please contact your local Schaffner partner for assistance.

11 Abbreviation

Ecosine Flex:	Refer to the product series Ecosine Flex Passive Harmonic Filters
PHF:	Passive Harmonic Filter
PWM:	Pulse Width Modulation
f_{PWM} :	Frequency of the PWM or switching frequency
TDJ:	Trap Disconnect Jumper module

[This page is intentionally left blank.]

To find your local partner within
Schaffner's global network, please visit
schaffner.com

The information contained within this document and the functions offered are solely intended to provide information about products available for purchase from Schaffner group companies ("Schaffner") and do not constitute an offer for purchase or sale or a recommendation or advice. The content of this document has been carefully prepared and reviewed and all reasonable efforts have been made to ensure the accuracy of the information. However, Schaffner does not warrant the accuracy and does not assume any liability whatsoever for any errors or inaccuracies of this document and the consequences thereof. Schaffner accepts no responsibility or liability for any losses or damages of any kind arising out of the use of this document or any of its related functions. Further, Schaffner cannot be held responsible for any errors or unexpected unfulfillment of shipments. Schaffner reserves the right to make changes to this document, the products, the published specifications and any other functions at any time without notice. Product suitability for any area of application must ultimately be determined by the customer. In all cases, products must never be operated outside their published specifications. Schaffner does not warrant, represent or guarantee the availability of any or all published products. The latest publications and product specification sheets as well as the current Schaffner general terms and conditions and data protection policy apply; these documents and the complete legal disclaimer can be downloaded from the Schaffner website. In order to improve readability, the masculine form is mainly used for people and personal nouns in this document. All references to persons apply equally to all genders. The abbreviated language form has only editorial reasons and does not imply any valuation.

All intellectual property rights, such as trademarks, tradenames, designs and copyrights, are reserved and are exclusively owned by Schaffner Holding AG. This document may exist also in other languages. This version is valid and binding.

This disclaimer shall be governed by substantive Swiss law and resulting disputes shall be settled by the courts at the place of business of Schaffner Holding AG.

© 2023 Schaffner Holding AG

